

YAMAHA

ROBOT

LINEUP CATALOG



YAMAHA ROBOT

Who we are and what we do

Over four decades of proven reliability

At Yamaha, development in the field of robotics began with the implementation of robotic technologies on our motorcycle production line over forty years ago. Since then, our industrial robot technologies have served as a backbone for manufacturing equipment in a wide variety of industries, including in the assembly of electronic products, the transport of in-vehicle components, and the manufacture of large LCD panels. Over the years, we at Yamaha have done our utmost to always continue improving upon what we've put to market. Those efforts serve as a testament to our reliability when it comes to producing what businesses need.



A legacy of unique technologies and a keen sense for market

Motor Control Technology is absolutely top-notch for high speed operation. Controller Development follows the highest standards of evaluation. And our technology allows for stable operation even under the most demanding conditions. Our products are characterized by high reliability, durability and operability, and our Core Technologies provide just what the market needs.



*Core Technologies refers to control boards, linear motors, linear scales (position detectors) and other such technologies.

Testing environments that guarantee greater reliability

At Yamaha, we continue evaluating our technologies to ensure that our products are reliable. During product development, we conduct assessments and tests in our own anechoic chambers* to ensure the kind of reliability and quality that businesses count on.



* Our anechoic chambers have been set up to help us in the overall development of EMC (Electro-Magnetic Compatibility) technologies deployed in products produced by Yamaha Group companies. This allows us to ensure compliance with international regulations and conformity with international standards.

Yamaha quality means safety

We have a system in place which integrates the areas of manufacturing, sales and technology into one well-oiled machine. We leverage this system to the utmost to produce consistency when it comes to inspection, manufacturing, assembly, inspection and shipping processes. This allows us to provide high levels of quality, affordable prices, and quick deliveries. Processing and machining for key components is all done in house. As a robot manufacturer, we provide the kind of quality that you will find nowhere else. And when it comes to quality control, our customers can expect only high-quality craftsmanship achieved by rigid adherence to strict standards.

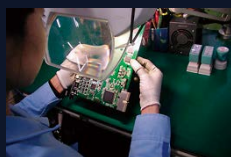

Robonity

SINGLE-AXIS ROBOTS / MOTOR

See p.22-23 for a quick selection table

We design our products for long-term
Both the single-axis robot and motor-

Slider type

Basic model

Motor-less single axis actuator

LBAS



Single-axis robots

ABAS



Integrated guide rail and frame design.
High moment rigidity in a compact design.

High Rigidity

Compact

Low Cost

Maximum payload	~ 115g
Maximum speed	300 ~ 1,800mm/sec
Stroke	50 ~ 1,250mm

Advanced model

Motor-less single axis actuator

LGXS



Single-axis robots

AGXS



Ground ball screw is standard.
High precision model with high reliability and durability.

High Precision Accuracy
Class C5

High Durability

Clean room specification as
a standard feature

Maximum payload	~ 160kg
Maximum speed	300 ~ 2,400mm/sec
Stroke	50 ~ 1,450mm

Series

-LESS SINGLE AXIS ACTUATOR

use so that you can use them safely for a long time.
less single-axis actuator can be selected.

Compact and high rigidity

Even though the product is more compact than the conventional product, it achieves a higher rigidity.

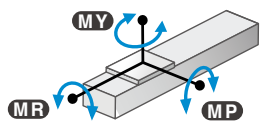

	Conventional product	LBAS05/ ABAS05	Conventional product	LBAS08/ ABAS08
MY	35	59	86	221
MP	40	63	133	309
MR	50	103	117	343
		(N · m)		(N · m)

First-class usability even at a low cost.

Reference surfaces are provided on the sides of the main body and knock holes are provided on the bottom to reduce design and assembly man-hours.

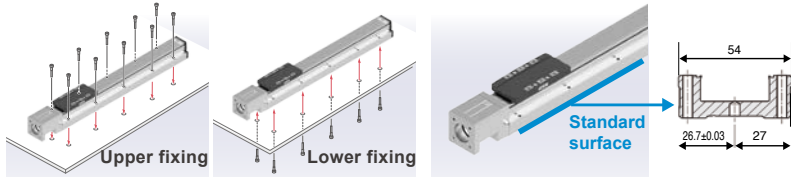

NEW

Suitable for the X-axis of Cartesian robots! Slim type "LBAS12/ABAS12" is added to the lineup.

The slim type structure achieves a low center of gravity, making it suitable for the X-axis of Cartesian robots. The overall height can be suppressed, contributing to equipment downsizing.

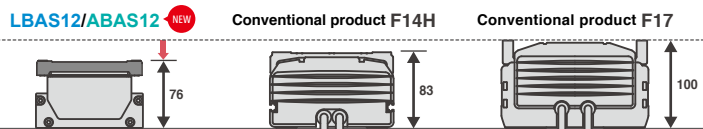

Overall length can be shortened by motor bending specifications.

Motor bending specifications can also be selected, expanding the range of design.

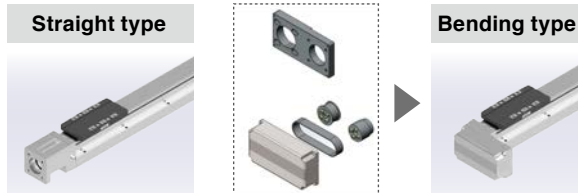

Easy Maintenance

Greasing work that tends to be troublesome, such as opening the covers, can be performed easily.

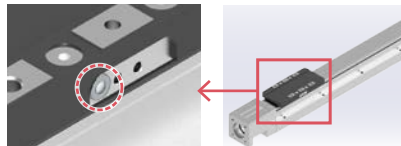

Grease nipple on the slider side surface

High quality model with high accuracy.

- Adopted ground ball screws
- Ball screw : Accuracy class C5
- Positioning repeatability: +/- 5 μm

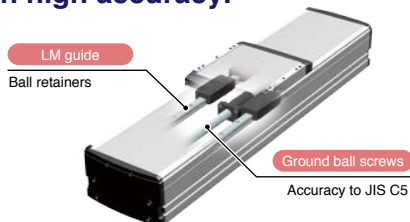

Overall length for effective stroke is the shortest class in the industry.

Overall length for the effective stroke is the shortest in class for the industry.

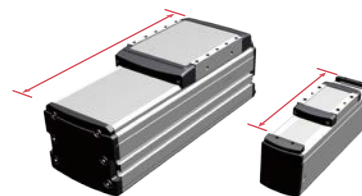

This product can be used in a wide range of situations.

Dust-proof stainless steel sheet is used on the top surface of the main body. Products can be used in a clean environment by attaching a pipe joint and suctioning. Air purging can also be used as anti-contamination measures. Of course, the product can be used as it is without attaching any joint.

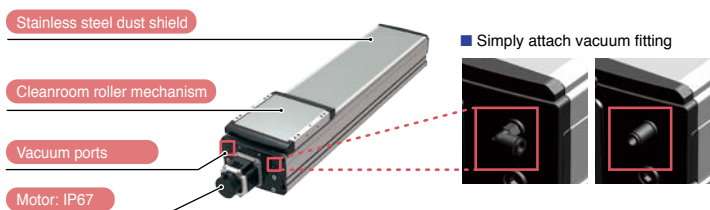

Robonity Series

SINGLE-AXIS ROBOTS / MOTOR-LESS SINGLE AXIS ACTUATOR

See p.22-23 for a quick selection table

NEW

Rod type

Basic model

Motor-less single axis actuator

LBAR

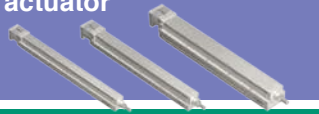

Single-axis robots

ABAR



High rigidity structure that follows the slider type.
Compatible with a long stroke of up to 800 mm.

High Rigidity

Compact

Long stroke

Maximum payload ~ 80kg
Maximum speed ~ 1200mm/sec
Stroke 50 ~ 800mm

Linear guide built-in rod type compatible with radial load. LBAR/ABAR

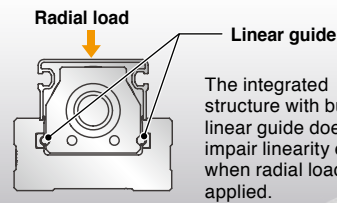

Rod non-rotation accuracy $\pm 0^\circ$

The built-in linear guide suppresses rattling in the rotation direction.
The working accuracy of the tool attached to the tip of the rod is maintained.

Conventional product SRD05	LBAR05/ABAR05	Diagram
$\pm 0.05^\circ$	$\pm 0^\circ$	

Compatible with a long stroke.

Compatible with a long stroke of up to 800 mm.
The corresponding stroke has doubled when compared to the conventional product with the same size.
This product can be used in a wide range of situations.

Conventional product SRD05	LBAR05/ABAR05	Conventional product SRD05	NEW LBAR05/ABAR05
300St	600St		

Twice as much as conventional

Easy installation and specification change

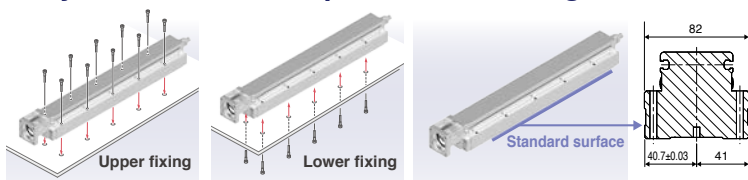

No external guide is needed.

External guide is not needed since the linear guide is built-in. *An external guide may be recommended when a certain stroke is exceeded.

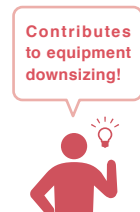
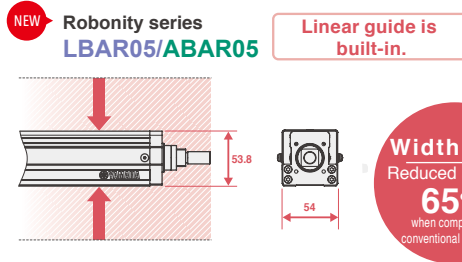
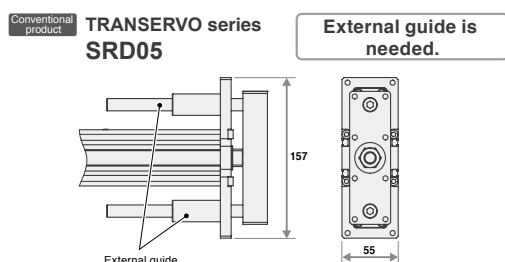



Robot positioner EP-01series

- Same price as parallel I/O and industrial Ethernet
- Absolute battery function
- Support software is provided free of charge.
- Industry-leading compactness

Robot positioner “EP-01” is a newly designed positioner for a better Ethernet platform and the cost performance. As a result the price of Ethernet is now offered at the same price level as parallel I/O (NPN).

While achieving a lower cost design, “EP-01” positioner has expanded features such as standard Ethernet, feedback pulse output, direct value control function, and real-time output.



[Supported field networks]



■ The hassle of startup is reduced.

Ethernet port is standard on a controller and dedicated PC programming cable is no longer required. Startup procedure is reduced and simplified.

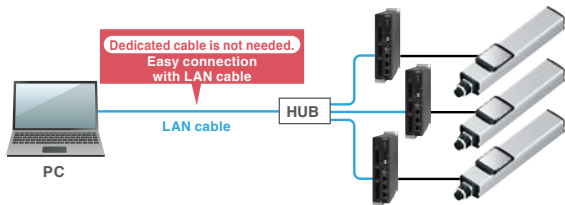

Industry-leading compact design

Compact design for machine size reduction.

■ Basic model (ABAS)

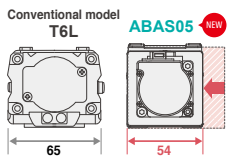

Width
Reduced approx. 17% compared to the conventional model.

■ Robot positioner EP-01

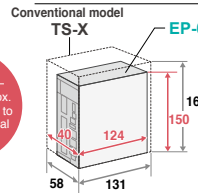

Capacity
Reduced approx. 37% compared to the conventional model.

■ Installation space comparison

Saves spaces inside a control panel

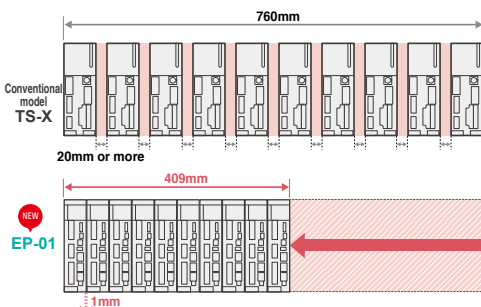

Installation area
Reduced approx. 47% compared to the conventional model.

Build a system with motor/driver of your choice

LBAS LGXS

In addition to the conventional servomotors, stepping motors are also newly supported and actuators can be used in accordance with customers' needs.
*For the supported models and capacities, see the Robonity catalog.

LBAS Compatible motor manufacturers and standards

[Servo motor]

Yasukawa Electric	Mitsubishi Electric	KEYENCE
OMRON	SANYO DENKI	TAMAGAWA SEIKI
DELTA ELECTRONICS	Panasonic	FANUC
Siemens AG	Rockwell Automation, Inc.	
Schneider Electric SA	KINGSERVO Hoof automation CO., LTD.	
Beckhoff Automation GmbH & Co. KG		

[Stepping motor]

Oriental Motor

[NEMA standards]

NEMA17 NEMA23

LGXS Compatible motor manufacturers

[Servo motor]

Yasukawa Electric	Mitsubishi Electric	KEYENCE
OMRON	Panasonic	

Easy model selection

» Simple cycle time and service life calculation.

The service life and cycle time can be calculated at the same time by simply entering the required information at the website. The result can be conveniently saved as PDF file.

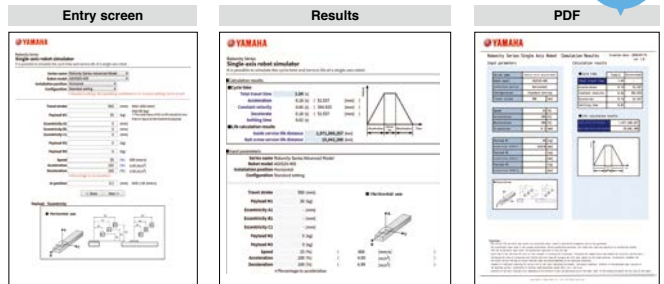

PC Programming software “EP-Manager” Free download

Support software “EP-Manager” that allows you to perform “Setting” → “Pre-check” → “Debug” → “Maintenance” in a single step is provided free of charge.

Easy edit for robot operation, positioning, timing, or monitoring motor load.

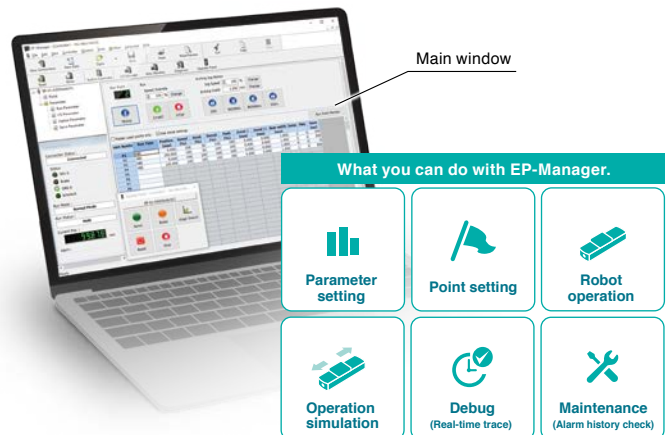

TRANSERVO Series

CLOSED LOOP STEPPER MOTOR SINGLE-AXIS ROBOTS

See p. 24 for a quick selection table

The TRANSERVO series brings to you compact and economical single-axis robots which feature a fusion of the low cost of a stepper motor and the functionality of a servo motor.

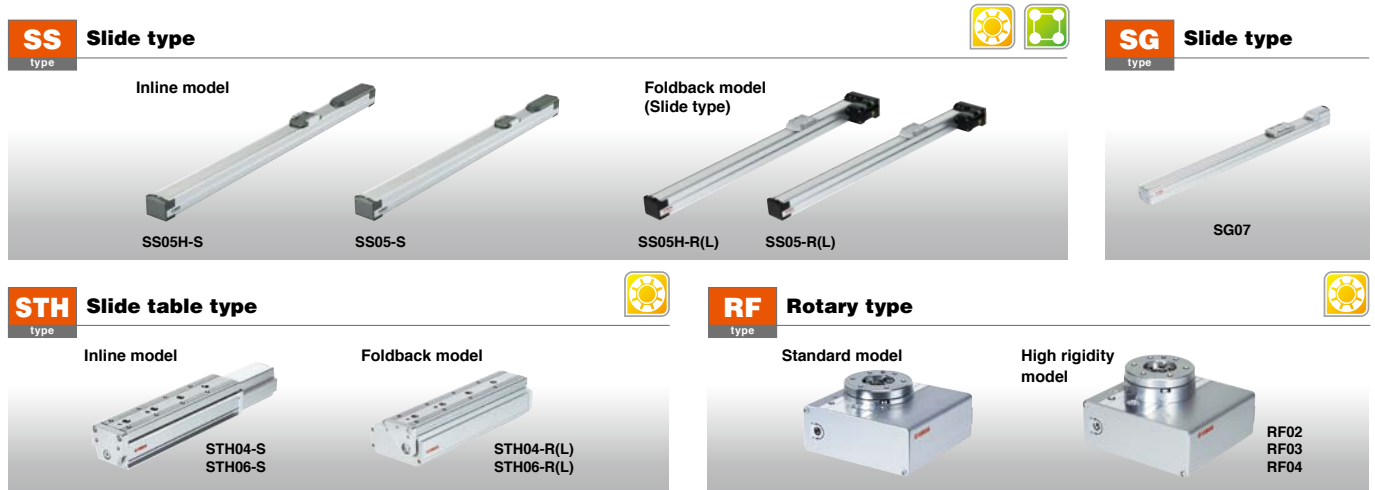

Closed-loop control for position feedback

While stepping motors can be deployed at a low cost, they experience drastic drops in torque at high speeds and offer no hunting oscillation (micro vibrations).

Our TRANSERVO series eliminates these problems with the deployment of an innovative vector control method, which means that the series delivers the same functionality of a servo motor with the lower cost of a stepping motor.

Stepping Motors	<ul style="list-style-type: none"> • Simple design & low cost • No vibration when stopped 	<ul style="list-style-type: none"> • High-pitched operating noise • Drop in torque at high speeds • Heavy power consumption when stopped
Servo Motors	<ul style="list-style-type: none"> • Smooth movement • Constant torque at all speeds • Saves energy 	<ul style="list-style-type: none"> • Micro vibrations occur when stopped • High cost

TRANSERVO brings together the best of both worlds

Features and benefits of the SG type (slider type)

Dynamic payload—46 kg horizontally and 20 kg vertically

Payload capacities are increased a great deal thanks to the deployment of a rigid table slide and a 56 motor. The result is a maximum payload of 46 kg, with the limit being 20 kg when it comes to transport using vertical specifications.

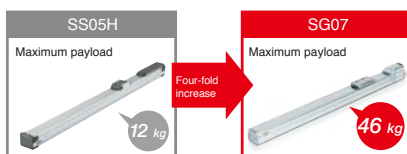

Maximum speed of 1200 mm/sec

The maximum speed provided is 1.2 times faster than that offered by the current model SS05H, making it possible for your equipment to reduce cycle time.

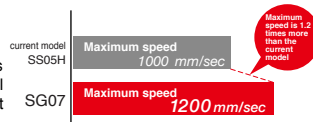

Features and benefits of the SS type (slide type)

High-speed operation means lower production time

TRANSERVO leverages the vector control method to the greatest extent possible to maintain a constant payload even under high speed conditions. This means a drastic reduction in cycle time. This combined with the high-load ball screws means that the TRANSERVO series provides a maximum speed of one meter per second,* which is as fast as single-axis servo motors found in the same category.

*SS05/SS05H/SSC05/SSC05H (lead: 20 mm)

High-speed operation means lower production time

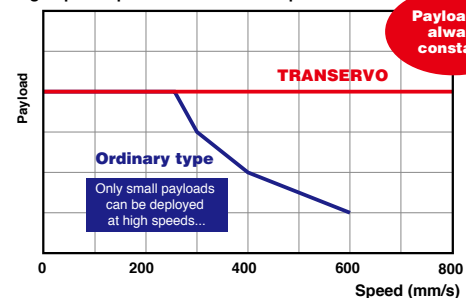

Longer service life thanks to two-point contact guides featuring four rows of circular grooves

Guides maintain the rolling movement required with minimal differential ball slippage, even when a large-momentum load is applied or when accuracy (flatness) on the installation surface is sub-par. This rugged design means that breakdowns resulting from abnormal wear and other such phenomena seldom occur.

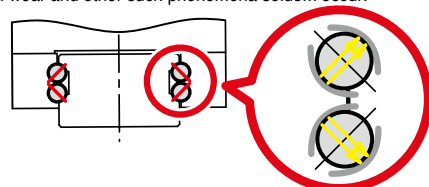



The position detector is a resolver

The resolver used features a simple yet sturdy structure employing no electronic components or optical elements. This makes it extremely tough and great for use in harsh environments. Breakdown rates are also kept low and the structure of the resolver experiences none of the detection-related problems seen in other detectors, such as optical encoders that experience breakdowns of electronic components or which see moisture or oil sticking to the disk.



SR Rod type



Standard model



SR05

SR04

Model with support guide



SRD05

SRD04

Foldback model



SR04-R

SRD04-U

BD Belt type



Inline model

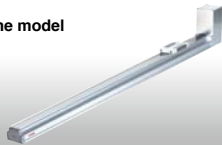

BD04
BD05
BD07

Features and benefits of the SR type (rod type)

Maintenance required less frequently

A lubricator used in the ball screw along with a contact scraper provide the product with a long service life extended periods where maintenance is not required.

- No maintenance needed for long periods of time
- Grease-saving lubrication system
- Prevents particle contamination

Ball screw lubricator

Lubricators keep grease within a high-density fiber net to supply just the right amount. Nothing is wasted.

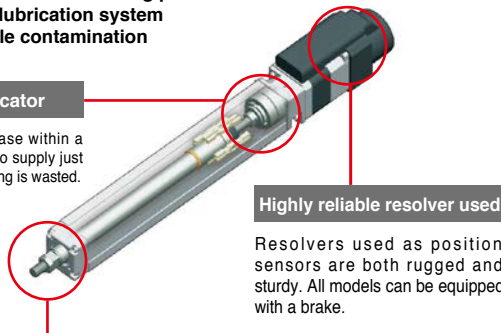

Highly reliable resolver used

Resolvers used as position sensors are both rugged and sturdy. All models can be equipped with a brake.

Layered contact scraper

A dual layer scraper prevents micro-contaminants on the rod from getting inside and also effectively curbs looseness or vibration in the rod.

Features and benefits of the BD type (belt type)

For long stroke applications

This product ensures high speed operation with its long maximum stroke of 2000 mm and a maximum transport speed of 1500 mm/sec. No exterior parts (such as the cover) need to be removed when installing. A shutter is also provided as a standard accessory, which securely covers the guide and belt to prevent grease from scattering about and serves to prevent contamination by foreign objects. This product is best suited for workpiece positioning or transport taking place over long distances.



The shutter comes as a standard accessory and protects internal mechanisms

Features and benefits of the STH type (slide table type)

Circulation type linear guide for high rigidity and accuracy

This product features a maximum pressing force of 180 N and a repeated positioning accuracy of ± 0.5 mm. Integrating a guide rail and slider ensures less bending and the circulation type linear guide provides high rigidity and accuracy. The allowable overhand provided by STH06 exceeds that seen in the T9 model of the FLIP-X series. The STH type is optimal for precise assembly.

Dowel pin for positioning

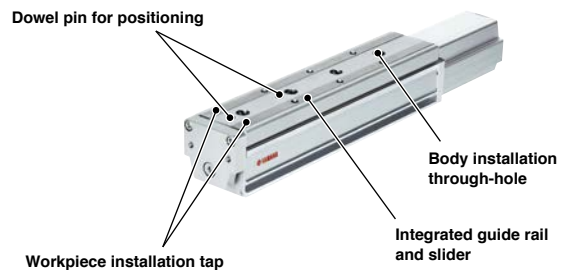

Workpiece installation tap

Body installation through-hole

Integrated guide rail and slider

Features and benefits of RF type (rotary type)

The first rotation axis model in the TRANSERVO series

Featuring a maximum speed of 420 degrees per second and a repeated positioning accuracy of ± 0.05 degrees, the RF type is a thin, electric rotary type actuator. There are two models which can be selected in accordance with the application: the standard type and a high-rigidity type. The RF type is very easy to use and allows for simple installation of the workpiece on the table and on the base frame. The RF type can be used for rotational transport taking place after chucking and for vertical rotation when combined with a gripper.

High-rigidity bearings mean less displacement in radial and thrust directions of the table



High rigidity model

FLIP-X Series

SINGLE-AXIS ROBOTS

See p. 25 for a quick selection table



Our single-axis robot series includes 6 types and 29 variations, meaning a broad range of options are available

T **Compact model**
type T4L/T4LH, T5L/T5LH, T6L, T9/T9H

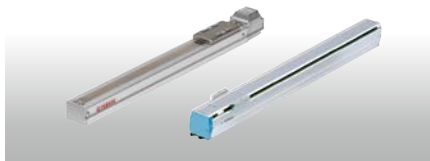

This model provides a compact body at an affordable price and is ideal for installation directly on a mount.

N **Nut rotation model**
type N15/N15D, N18/N18D

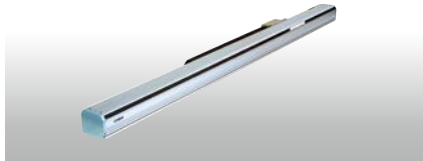

This model allows for operation even under long stroke conditions, all while maintaining maximum speed and remaining unaffected by critical speed. Double carrier specifications also come standard.

F **GF** **High rigidity model**
type F8/F8L/F8LH, F10/F10H, F14/F14H, F17/F17L, F20/F20N, GF14XL/GF17XL



The model features a highly rigid aluminum frame, which provides high levels of load moment and offers strength against offset loads. The model is suitable for use in Cartesian robots requiring arm rigidity and for moving arms which move the overall axis.

B **Timing belt drive model**
type B10, B14/B14H

With a maximum stroke length of 3050 mm, this model allows for long-distance transport between job processes.



R **Rotary axis model**
type R5, R10, R20

This model provides a repeated positioning accuracy of ± 30 seconds (meaning 0.0083 degrees). The R type can be combined with other robots for use as the rotation axis or for a broad range of other applications, like index tables. The product's harmonic driver provides great strength and accuracy.



A resolver built for harsh environments



A highly reliable resolver is used for the detection of motor positions, which ensures the steady detection of positions even under harsh conditions where powder particles or oil mist is found. When it comes to resolution performance, the resolver provides an amazing 20480 pulses per revolution.

Optical encoder



- Optical
- Complicated structure with electronic parts required
- Trouble with electronic parts, condensation of dew and the sticking of oil on the disc occur more frequently

Risk of detection failure

Resolver



- Magnetic type
- A simple structure comprised of an iron core and winding means less potential for failure
- Highly impact resistant and resilient against electronic noise

High reliability

Two-point contact guides featuring four rows of circular grooves help in dealing with large moment loads



Two-point contact guides featuring four rows of circular grooves allow for less differential slip. Differential slip experienced by the ball is low when compared to four-point contact guides with two rows of Gothic arch grooves. This means that excellent rolling motions are provided even when dealing with large moment loads or poor installation surface accuracy. Malfunctions, such as that resulting from unusual wear, are also much less frequent.

Conventional
Four-point contact guides with two rows of Gothic arch grooves

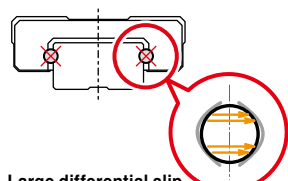

Large differential slip and resistance to friction

- Highly impacted by poor installation precision, friction and elastic deformation
- May break down even during the calculated service life

Yamaha
Two-point contact guides featuring four rows of circular grooves

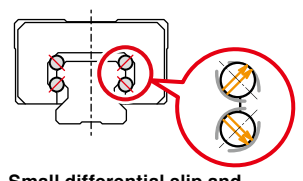

Small differential slip and good self-centering

- Highly resistant to alignment fluctuations and moment loads
- Seldom breaks

Customization for each model available

If you are looking to do special orders for any of our models (double sliders, wide sliders, etc.), please inquire with a sales representative.

A long service life means you save on maintenance and management

Our highly rigid ball screws and guides are a huge help in letting you save on maintenance and management costs. Visit our website to find out what you can expect in terms of the service life of a given product under certain conditions.



PHASER Series

LINEAR MOTOR SINGLE-AXIS ROBOTS

See p. 26 for a quick selection table



No critical speed restrictions required up to long strokes of 4 meters
Excellent performance during long-distance transport

MF

Long stroke and high power using a flat motor with a core

type

Double carrier comes standard

- **Maximum stroke: 4050 mm**
- **Maximum speed: 2500 mm/s**
- **Repeated positioning accuracy: +/- 5 µm**
- **Maximum payload: 7kg to 160 kg**

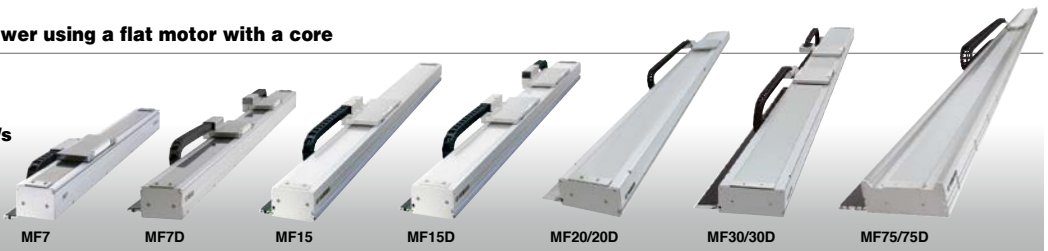

Yamaha in-house components means lower costs

Magnetic scales originally developed by Yamaha are still being produced by us today. We also manufacture other major components to ensure significant reductions in cost. Linear mechanisms are no longer something special as we are now in an era where they can stand shoulder to shoulder with ball screws as the right tool for the job.

The linear motor type will particularly provide lower costs when it comes to transporting lightweight workpieces over long distances at high speeds.

MF7 (Linear motor)

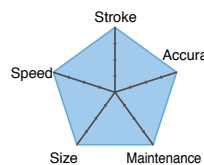

F17 (Ball screws)

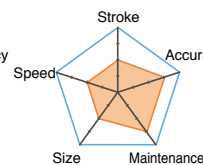

B10 (Belt type)

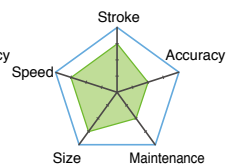

Comparison of single-axis robot models

Model	Unit cost ¹	Maximum speed (mm/sec)	Payload (kg)	Repeated position accuracy (µm)	Maximum stroke (mm)	Frame dimension ² (W x H) (mm)
MF7-1500		2500	10 (7) ³	+/-5	4000	85 x 80
F17-40-145		720 ⁴	40	+/-10	1450	168 x 100
B10-1450		1850	10	+/-40	2550	100 x 81

1. Comparisons using the strokes noted above. 2. Cable carrier not included. 3. Becomes 7 kg when the maximum speed is 2500 mm/s (meaning 2100 mm/s when transferring 10kg). 4. Value determined in consideration of critical speed when the stroke is 1,450 mm.

High speed, long travel

The ultimate appeal of linear motor single-axis robots is that there are critical speed limits like you would see when dealing with ball screws. Even long-distance travel means no reduction in maximum speeds. Standard maximum stroke goes up to 1050 mm with the MR type and up to 4000 mm with the MF type. Cycles times for long-distance transport have particularly seen drastic improvements.

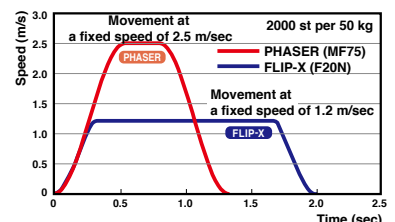

Movement profile of linear single-axis PHASER and single-axis robot FLIP-X

Standard double carrier setup saves spaces and ensures great efficiency

This product allows you to lower the costs involved and decrease spaced used in comparison to the usage of two single-axis robots. No axis alignment is needed and tools can be shared, which shortens setup time. Lastly, an anti-collision control function is provided when making use of the RCX series controller.

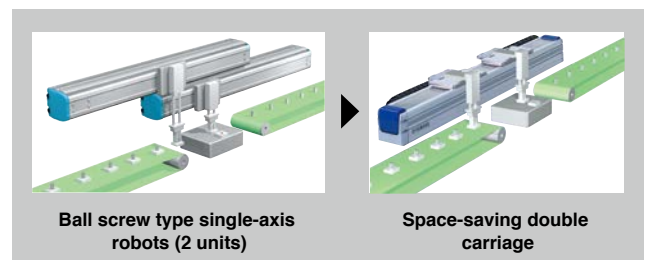

Maximum payload capacity of the MF series: 160 kg

Flat magnets are deployed within the MF series, meaning that heavy objects can be transported at high speeds with a high level of accuracy.

Lower noise levels and longer service lives

When compared with ball screw type robots, there are fewer sliding and rotating sections, meaning that operation is exceedingly quiet. Coils and magnets do not make contact, meaning no wear is experienced, making the the robot usable for extended periods of time.

G X Series

SINGLE-AXIS ROBOTS



See p. 26 for a quick selection table

Highly efficient, highly accurate ground ball screws are now standard feature for all types and models. The high precision models with reliability and durability.

High precision, high rigidity, high durability Reliability

All product models employ highly efficient, highly accurate ground ball screws as the standard features. The lead accuracy complies with JIS accuracy class C5 that brings about the positioning accuracy repeatability of $\pm 5 \mu\text{m}$. The accuracy is about two times higher than the previous models. These new features contribute to improving yield. In addition, noise level is reduced and structural life is extended serv.

LM guide

Ball retainers

Ground ball screws

Accuracy to JIS C5

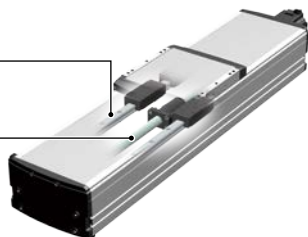

Shortest overall length in the industry Save space

The industry's shortest class is achieved for the total length in relation to the operation stroke. This significantly contributes to saving production facility footprints.

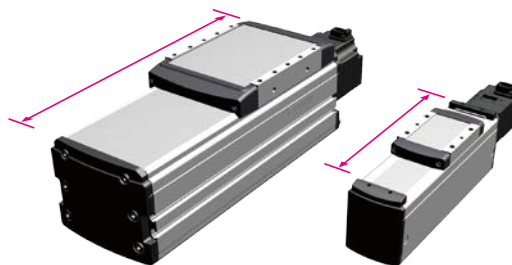

All models can be mounted (fixed) from the top surface or bottom surface

Usability

Save space

The main unit can be fixed from either the bottom face or top face to respond to the system's densification and space saving.

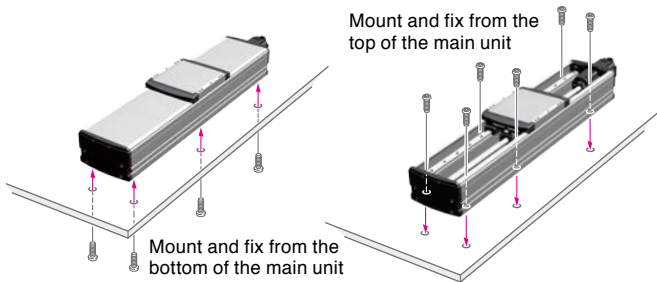

Clean specification as a standard feature Environment resistance

Dust-proof structure

Upper surface of main frame of all models is protected with durable stainless steel dust shield. This structure helps reducing foreign particle contamination from outside. By applying negative air pressure from suction port it can be used in a clean environment.

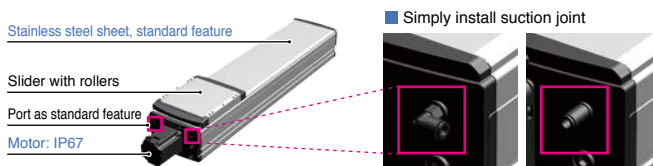

Easy to alter specifications

Usability

Save space

Options available for retrofit

Converting cable outlet orientation

With conversion adapter on a standard motor orientation of cable outlet can be changed.

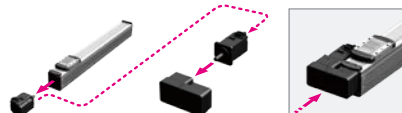
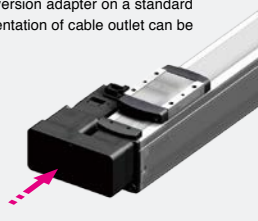

Simply remove the motor from the robot body, set it onto the conversion adapter, and then mount onto the body again.

Changing the location of robot cable outlet

The direction of cable outlet can be converted to customer's preference.

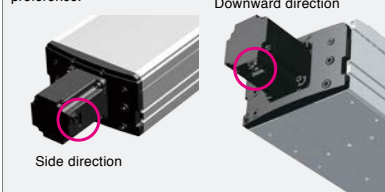

Unscrew motor fixing bolts

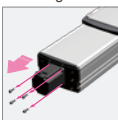

Reposition the motor



Battery-less absolute system / No origin process needed Usability

The complete absolute method is adopted so there is no need to perform return-to-origin when restart and initial start up process. The battery-less absolute is also supported.

XY-X Series

CARTESIAN ROBOTS



See p. 26 for a quick selection table

From compact, economical and light-duty systems to large, heavy-duty systems, a variety of pre-configured multi-axis systems are available

Custom orders

Custom multi-axis systems are also available. Please inquire with a Yamaha representative near you.

Arm type



Gantry type

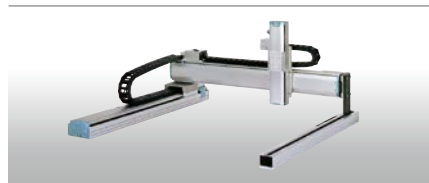

Moving arm type



XZ type

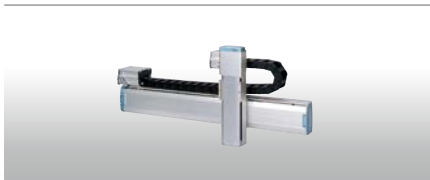

Pole type

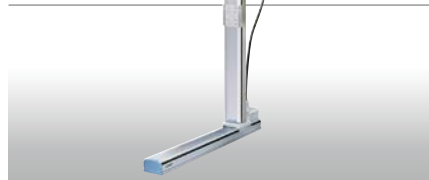

Dual-synchronous drive

The dual-synchronous drive has two axes being controlled in synchronization with one another. This means that they are effective for the carrying of heavy items and for long stroke operation with a Cartesian robot.

Note: Custom orders are required for dual drive functionality.

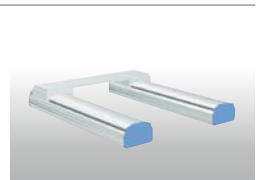

Variations



For specifications involving 3 or more axes, please select from the following:

- Z-axis clamped base and moving table type
- Z-axis clamped table and moving base type

Resolver provides durability and reliable position detection



The position detector is a resolver featuring a simple yet robust structure which uses no electronic components or optical elements, making it extremely tough for usage in harsh conditions. It also seldom breaks down. The structure of the resolver presents none of the detection issues seen in other detectors, such as optical encoders with electronic components which experience breakdown or have moisture and oil sticking to the disc. **The mechanical specifications when it comes absolute specifications and incremental specifications are shared by all controllers**, meaning that you can switch to either absolute or incremental specifications with the mere setting of parameters.

Even if the absolute battery gets completely worn down, the XY-X can operate based on incremental specifications, meaning that the production lines never need to be halted if trouble occurs. Backup circuits have been completely overhauled as well, meaning a backup period of one year.

Save money

Cutting down on the number of parts while boosting performance has allowed us to lower our prices. The inclusion of a resolver within the structure means that we have eliminated the idea that absolute units have to be expensive. What's more, mechanical components remain unchanged regardless of whether incremental unit specifications or absolute unit specifications are being used.

Maintenance is easy

Though a built-in structure is employed, maintenance is made simple thanks to the ability to replace components like motors and ball screws on an individual basis.

Two-point contact guides featuring four rows of circular grooves



Two-point contact guides featuring four rows of circular grooves allow for less differential slip. Differential slip experienced by the ball is low when compared to four-point contact guides with two rows of Gothic arch grooves. This means that excellent rolling motions are provided even when dealing with large moment loads or poor installation surface accuracy. Malfunctions, such as that resulting from unusual wear, are also much less frequent.

Four-point contact guides with two rows of Gothic arch grooves

Large differential slip and resistance to friction

- Highly impacted by poor installation precision, friction and elastic deformation
- May break down even during the calculated service life

Two-point contact guides featuring four rows of circular grooves

Small differential slip and good self-centering

- Highly resistant to alignment fluctuations and moment loads
- Seldom breaks

YK-X Series

SCARA ROBOTS

- YK-XG Direct drive beltless model
- YK-XE Low cost high performance model
- YK-XGS Wall mount/inverse model
- YK-XGP Dust-proof & drip-proof model

See p. 27 for a quick selection table



An outstanding, diverse lineup featuring arm lengths ranging from 120 to 1200 mm. Delivers high-speed and high-precision operations for increased productivity.

Extra small type SCARA model

YK120XG, YK150XG
YK180XG, YK180X
YK220X

- Arm length: 120 mm to 220 mm
- Maximum payload: 1 kg

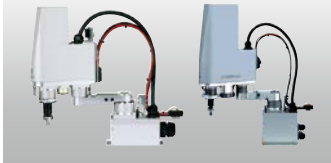

This model provides the only completely beltless structure found in this class and you can look forward to high levels of rigidity and accuracy even with the extra small type. Maxim speeds have also been improved dramatically when compared to the previous model, which was achieved by increasing the maximum RPM of the motor.

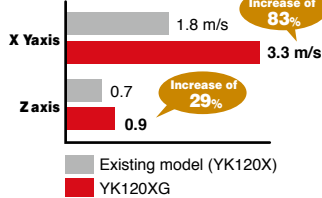

Low cost high performance model

YK400XE-4
YK510XE-10
YK610XE-10
YK710XE-10

- Arm length: 400 mm to 710 mm
- Maximum payload: 4 kg to 10 kg



Small type

YK250XG
YK350XG
YK400XG



- Arm length: 250 mm to 400 mm
- Maximum payload: 5 kg

Medium type

YK500XGL / XG
YK600XGL / XG/XGH



- Arm length: 500 mm to 600 mm
- Maximum payload: 5 kg to 20 kg

Large type

YK700XGL
YK700XG
YK800XG
YK900XG
YK1000XG
YK1200X



- Arm length: 700 mm to 1,200 mm
- Maximum payload: 10 kg to 50 kg

Note: YK700XGL is available for custom orders. Please inquire with a Yamaha representative for more details.

Wall mount/inverse type

YK300XGS, YK400XGS
YK500XGS, YK600XGS
YK700XGS, YK800XGS
YK900XGS,
YK1000XGS

- Arm length: 300 mm to 1,000 mm
- Maximum payload: 20 kg



Wall-mount type

This type is used when the robot body is installed on a wall.

Inverse type

This type is used in cases where the wall-mount type is mounted upside down.

Dust-proof & drip-proof model

YK250XGP, YK350XGP
YK400XGP, YK500XGP
YK500XGLP, YK600XGP
YK600XGLP, YK700XGP
YK800XGP, YK900XGP
YK1000XGP,

- Arm length: 250 mm to 1,000 mm
- Maximum payload: 20 kg



This model is designed for work environments involving frequent water splashing and dust (with the protection class being equivalent to IP65).
• If you need protection from moisture generated by anything other than water, please contact us.
Note: YK700GP/YK800XGP/YK1000XGP are custom order models. Please inquire with a Yamaha representative for more details.

40 years of history

SCARA was our first robot. Since producing our first SCARA robot called CAME, we have spent some forty years bringing SCARA robot innovations to market. SCARA robots have undergone countless modifications in an ever-changing marketplace. The extensive track record we have built with SCARA robots have made them an essential part of the Yamaha robot lineup.



Internal structure designed for optimal operation

Note: The example shown is YK500XG

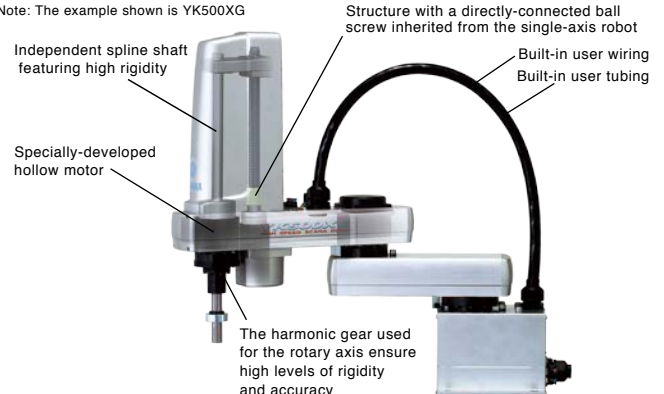

Completely beltless structure

A ZR-axis direct coupling structure allows for a totally beltless structure. This direct drive structure means a dramatic reduction in wasted motion. It also serves to maintain high levels of accuracy over long periods of time and ensure maintenance-free usage over extended periods of time, meaning there is no need to worry about breakage, stretching or deterioration of the belt with age. This feature applies to all XG series models and to YK180X/YK22X.

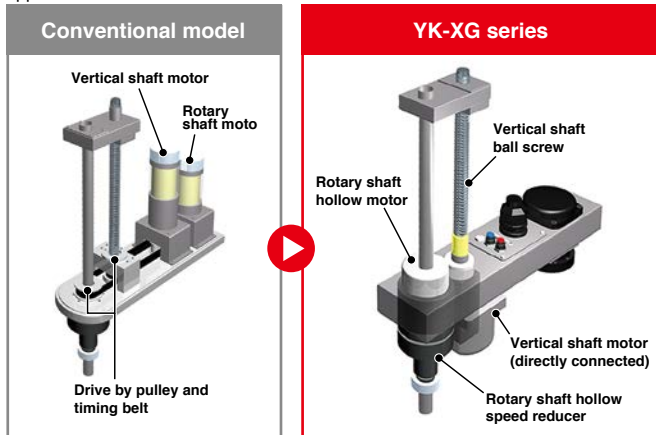

Environmentally rugged resolver used for position detection

The position detector is a resolver featuring a simple yet robust structure which uses no electronic components or elements, making it extremely tough for usage in harsh conditions. It also seldom breaks down. The structure of the resolver presents none of the detection issues seen in other detectors, such as optical encoders with electronic components which experience breakdown or have moisture and oil sticking to the disc. **The mechanical specifications when it comes absolute specifications and incremental specifications are shared by all controllers**, meaning that you can switch to either absolute or incremental specifications with the mere setting of parameters. Even if the absolute battery gets completely worn down, the SCARA can operate based on incremental specifications, meaning that the production lines never need to be halted if trouble occurs. Backup circuits have been completely overhauled as well, meaning a backup period of one year.

Note: The resolver is comprised of a simple structure which forgoes the usage of any electronic components. It is highly resistant to both high and low temperatures, impacts, electronic noise, dust particles, oil and other elements. The resolver is used in automobiles, trains and airplanes.

Optical encoder	Resolver
<ul style="list-style-type: none"> Optical Complicated structure with electronic parts required Trouble with electronic parts, condensation of dew and the sticking of oil on the disc occur more frequently <p>Risk of detection failure</p>	<ul style="list-style-type: none"> Magnetic type A simple structure comprised of an iron core and winding means less potential for failure Highly impact resistant and resilient against electronic noise <p>High reliability</p>

Superior rotary axis inertia moment capacity

SCARA robot performance is demonstrable by the standard cycle time alone. The robot allows for a diverse range of heavy workpieces to be dealt with as well as large offsets. Having a low axis inertia moment when it comes to the R axis helps drastically in reducing cycle times. All SCARA robots produced we produce come with speed reducers directly attached to the tip of the rotating axis, meaning the R axis produces an extremely high allowable inertia moment which provides higher speeds in terms of operation when compared to structures where positioning is usually dealt with by a belt after deceleration takes place.

YK120XG
(Allowable moment inertia of the R axis: 0.1 kgfcm²)

If the weight load at the tip is 1 kg, operation will be possible with an offset of about 100 mm.

• Allowable inertia moment of the R axis Comparison of YK120XG and a competitor's model

Figures when using a 1 kg load		Operation	
Offset (mm)	Inertia (kgfcm ²)	YK120XG	Company A
0	0.0039	○	○
45	0.025	○	×
97	0.1	○	×

◆ Allowable inertia moment of the R axis YK120XG: 0.1 kgfcm²
Company A: 0.0039 0.1 kgfcm²

High speed

While standard cycle times are no doubt fast, our designs also put a focus on cycle times in the regions where usage is taking place. Drastic improvements in maximum speeds were achieved through changes made to gear ratios and maximum motor RPM, resulting in better cycle times during long-distance movement.

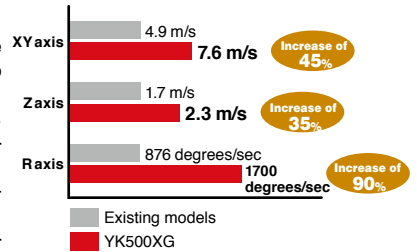

Hollow shaft and tool flange options available

Useful additions include a hollow shaft to facilitate easy wiring leading to the tip of the tool and a tool flange used for clamping tools.

Note: YK250XG/YK350XG/YK400XG/YK500XGL/YK600XGL/YK610XE-10/YK710XE-10



A hollow shaft makes for easy touring of air tubes and harness wires

A tool flange makes it easy to mount a tool to the tip

Improved maintenance features

Covers used in the Yamaha SCARA robot YK-XG series can be removed from the front or in an upwards motion. Maintenance is easy since covers are completely unattached to the cable. When it comes to replacing grease on a harmonic gear, ordinary robots require a great deal of time and effort since gears must be disassembled and because position deviations may occur. Yamaha SCARA robots, however, feature grease-sealed harmonic gears, meaning that no grease replacement is required (YK500XG to YK1000XG).

Affordable, superior performance

The model provides improved efficiency and reliability when deployed in production at an affordable price.

YK-XE

Features of the wall mount/inverse type

A completely beltless structures ensures high rigidity

YK-XGS

Flexibility in terms of system designed improved as a result of having the conventional ceiling mount type model changed to a wall mount type. This makes possible the downsizing of production equipment. With the addition of the inverse type to the lineup (which allows for upward operation), flexibility was also increased in terms of work directions. What's more, a completely beltless structure means that there is a maximum payload of 20 kg and an allowable inertia moment of the R axis of 1 kgm². This is the highest level available in the same class. Large hands can also be installed, making this robot suitable for work entailing heavy loads.

*YK700XGS to YK1000XGS

Dust-proof and drip-proof type

Bellows provide improved dust/drip-proofing

YK-XGP

Previous robot models were completely overhauled to create a model type* that is dust proof, drip proof and features an entirely beltless structure deployable in working environments were water droplets or dust particles are found scattering about.

This model type eliminates the issue of belt deterioration and is perfect for usage in harsh environments. The use of an up/down bellows-based structure also allows for improvements in terms of dust proofing and drip proofing capabilities.

*YK250XGP to YK600XGLP

• Equivalent to a protection grade of IP65 (IEC60529)

• Dust-proof and drip-proof connector for user wiring comes standard

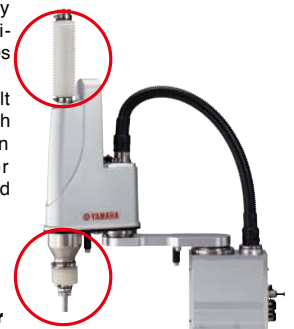

YK-TW Series

ORBIT TYPE SCARA ROBOT

YK350TW
YK500TW



See p. 27 for a quick selection table

Equipped with high positioning accuracy and high speed. Defeats the limitations of other SCARA and parallel-link robots, leaving smaller equipment footprint and no dead space at the center of the work envelope.

Covers bases within a 1,000-millimeter*2 reach

The YK-TW series features SCARA robots with wide rotation angles and a ceiling-mount configuration, with the YK500TW model capable of a reach of up to 1,000 mm under the arm. This greatly reduces footprint and lets them be free of movement restrictions during palletizing and conveyor or belt assembly operations.

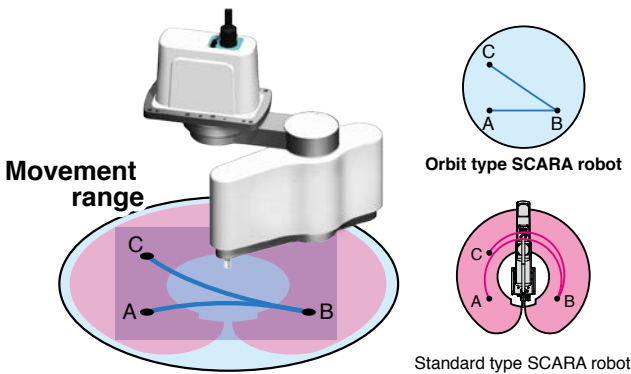

Repeated positioning accuracy: +/-0.01 mm*1 (XY axes)

YK-TW robots boast higher repeated positioning accuracy than that of parallel-link robots. This was achieved by striving optimal weight balance and re-designing the robots' internal construction. Furthermore, the robots are equipped with highly rigid but lightweight robotic arms that are fitted with finely tuned motors, allowing them to perform with high precision.

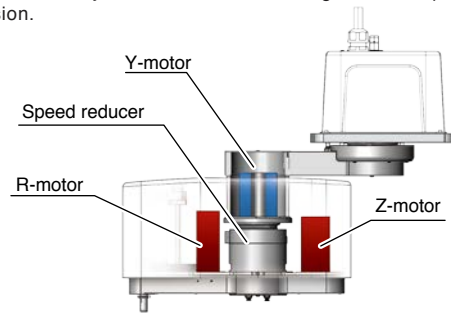

Hollow construction

Coupled Y-axis motor and speed reducer unit with hollow construction enables wire harness to be inside of moving arm housing.

Enabling 360-degree rotation

Optimized gravitational moment for rotation

Obtained weight balance by placing R-motor and Z-motor on the left and right.

High speed, reduced inertia

Ideal for work in narrow spaces

Minimum installation width **492 mm**

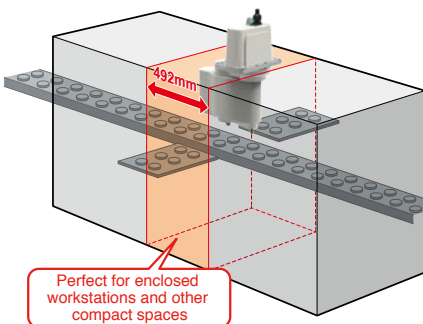

Freedom of movement

Full use of workspace underneath the unit

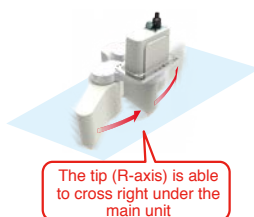

Lower profile, small footprint

The YK500TW is only 392 mm in height. Not only does it require little space, it also gives greater freedom when adjusting its layout.

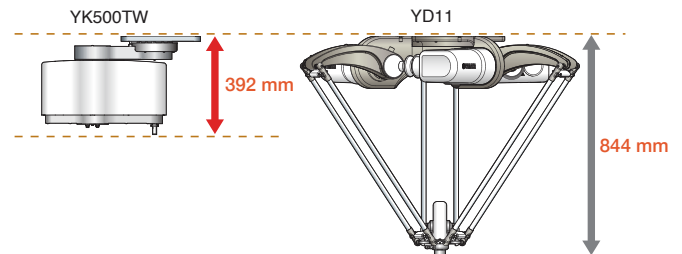

Standard cycle time down to 0.29 seconds*2

TK-TW robots are able to move with more flexibility in a horizontal plane. They are built with a second arm (Y-axis) that moves under the first (X-axis). Due to their multiple-joint structure, TK-TW robots can move more efficiently from point-to-point. Furthermore, with the weight balance of the internal components optimized, TK-TW robots have their cycle time reduced by 36% as compared to previous models.

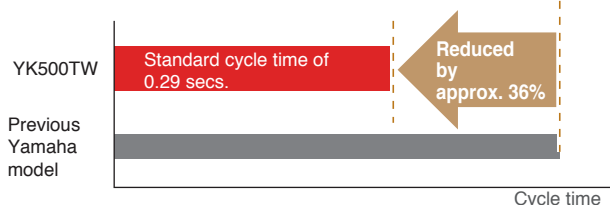

The standard cycle time for moving a 1-kg load 300 mm horizontally and 25 mm vertically has been reduced by approximately 36% compared to older Yamaha models.

Only 392 mm and 27 kg*2 Lower inertia, no bulky frame.

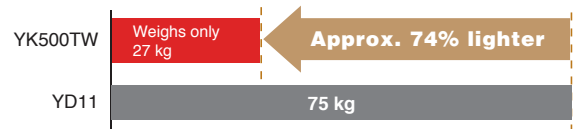

The YK-TW series comes with an optional installation frame. For more details, please contact a Yamaha sales representative.

*1. Applies to the YK350TW *2. Applies to the YK500TW

MULTI-FLIP / MULTI-PHASER

MULTI-AXIS ROBOT



One controller for multiple single-axis robots

Advantages of multi-axis controller operation

- Sequence control is simple and system upgrades are inexpensive
- More compact and saves more space than situations where multiple single-axis controllers are being operated
- Allows for a greater level of control
- RC320 and RCX340 (multi-axis controllers) provided mixed control involving the PHASER series (linear single-axis) and FLIP-X series

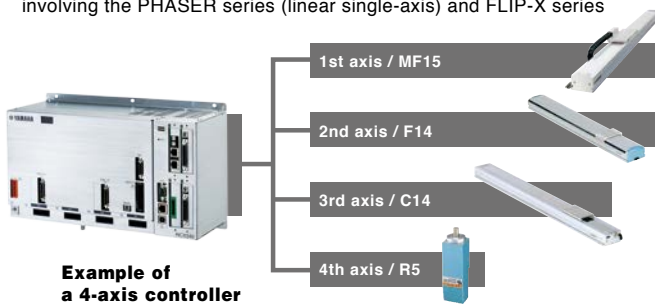

Robot setup

2-unit robot configuration

A multi-task program used with this configuration allows for asynchronous, independent operation. Using this alongside an auxiliary axis configuration means even more freedom when it comes to assigning an axis to a task.

Synchronized double configuration

This configuration allows for the addition of two motors to one axis on types of robots where motor units run separately, such as the linear motor single-axis PHASER series or the N type (nut rotation type) FLIP X series.

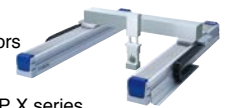

Main auxiliary axis configuration

Use this auxiliary axis configuration when it's impossible to have simultaneous movement take place using the MOVE command. Axes configured as main auxiliary axes move only with the DRIVE command (meaning a separate movement command issued to a particular axis) and cannot be operate via the MOVE command. That means this configuration is recommended for operation on an axis not synchronized with the main robot.

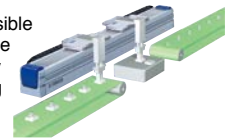

Synchronized dual configuration

Set things up like this when conducting dual-drive operation (meaning simultaneous control of two axes). Use this dual-drive configuration on gantry-type Cartesian robots characterized by a long Y-axis stroke when going about stabilization during high levels of acceleration or deceleration, or in situations involving heavy loads and high levels of thrust.

YP-X Series

PICK & PLACE ROBOTS

See p. 27 for a quick selection table

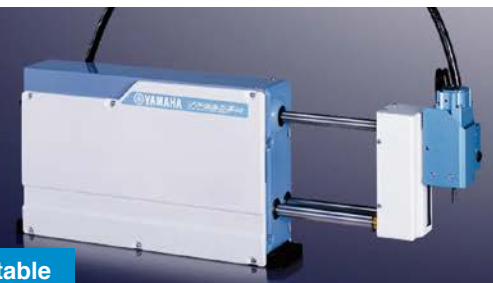

Ideal for picking and placing small parts at high speeds

Positioning via servo control means no mechanical adjustments required

2-axis type

YP220BX
YP320X



3-axis type

YP220BXR
YP320XR
YP330X



4-axis type

YP340X

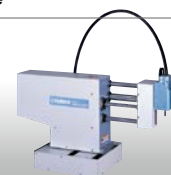

High speed

Ultra high-speed picking and placing means greater productivity. The YP22BX, when used under operating conditions involving 50 mm in the vertical direction, 50 mm in the longitudinal direction, 50 in terms of arch volume and a 1 kg load, provides a total cycle time of 0.45 seconds.

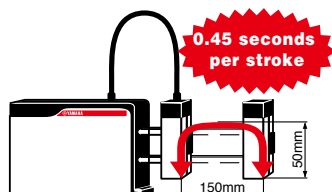

High precision

The YP320X, YP320XR, YP330X and the YP340X provide both excellent high-speed performance and high repeated positioning accuracy (± 0.02 mm).

Compact size

The YP220BX unit has a compact size with an overall length of 109 mm. The moving arm mechanism allows for the building of a compact production line that interferes less with its surroundings.

CLEAN Type

CLEAN ROBOTS

See p. 28-29 for a quick selection table



Designed for the electronics, food, and medical industries, and engineered for great suction and low particle emission. Delivers high cleanliness and excellent performance.

YK-XGC/XC

type

Clean room SCARA robots

- Arm length: 180 mm to 1,000 mm
- Suction rate: 30 to 60 NI/min
- Cleanliness class: ISO 3 (ISO14644-1)
Class 10 (FED-STD-209D)
- Maximum payload: 20 kg



YK250XGC



YK400XGC

The Z-axis spline shaft is protected with bellows made of low dust emitting material and other sliding mechanisms are sealed completely. The entire harness assembly is incorporated inside the housing, and dust emission is prevented by the air suction ports located on the back of the base housing.

Vertical bellows improve cleanliness reliability

FLIP-XC

type

Single-axis clean room robots

- Stroke: 50 mm to 2,050 mm
- Suction rate: 15 to 90 NI/min
- Cleanliness class: Class 10*
- Maximum payload: 120 kg (horizontal installation)

* C4L/C4LH, C5L/C5LH, and C6L conform to class ISO 3 (ISO14644-1).



C6L

C5L

C4L

Specifications of the FLIP-X series. Whether it is a lightweight, compact model, or one with a maximum payload of 120 kg, choose one that suits your needs from the 14 available. To achieve high cleanliness, these robots have suction joints installed as standard features and use grease with low dust emission. Their slide tables are also mounted with stainless steel sheets of excellent durability.

Fully beltless for higher rigidity

SSC

type

Single-axis clean room robots (TRANSERVO)

- Stroke: 50 mm to 800 mm
- Suction rate: 15 to 80 NI/min
- Cleanliness class: Class 10
- Maximum payload: 12 kg (horizontal installation)

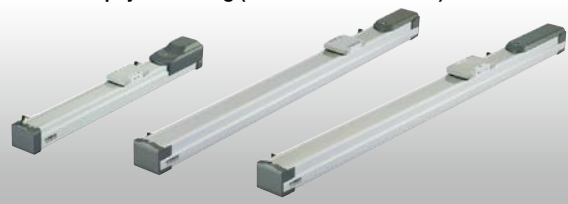

SSC04

SSC05

SSC05H

Specifications of the TRANSERVO series. TRANSERVO robots use stepper motors and a newly developed vector control system to keep performance costs low and achieve functionality similar to servomotors*. To achieve high cleanliness, these robots have suction joints installed as standard features and use grease with low dust emission. Their slide tables are also mounted with stainless steel sheets of excellent durability.

Easy to maintain

XY-XC

type

Clean room cartesian robots

- Suction rate: 60 to 90 NI/min
- Cleanliness class: Class 10
- Maximum payload: 20 kg
- Maximum speed: 1000 mm/sec

User wiring: D-Sub 25-pin connector (#1-#24 terminated, #25 grounded)

User piping: Three 6-mm diameter air tubes



SXYxC

Cartesian robots for clean rooms. Using stainless steel sheets of high durability allows openings to be designed to the smallest possible, and the robots are capable of supporting Class 10 environments with minimal suction. Furthermore, with SCARA robots' high-speed units used for SXYxC robots' ZR-axis, cycle time is reduced significantly.

CONTROLLERS



Choose what fits your needs from a wide range of control systems. Controllers come pre-programmed with servo parameters and acceleration patterns so you can operate the robot straightaway.

	TRANSERVO	Robonity	FLIP-X	PHASER
	Stepper motors	[ABAS/ABAR/AGXS] General purpose servos	[T4L/T5L] Small servos (24V, 30W)	General purpose servos (30-600W)
1 axis	<ul style="list-style-type: none"> • I/O point trace • Remote command • Online command 			
	<ul style="list-style-type: none"> • Pulse train 			
	<ul style="list-style-type: none"> • Program (Yamaha SRC language) • I/O point trace • Remote command • Online command 			
2 axes				
	<ul style="list-style-type: none"> • Program (Yamaha BASIC language) • I/O point trace • Remote command • Online command 			
3 or 4 axes				
up to 16 axes	<p>YC-Link/E</p> <p>RCX340 is capable of controlling up to four robots (or 16 axes)</p> <p>The master controller controls all programs and settings.</p> <p>With YC-Link/E, the Master can be connected to the Slaves using LAN cables.</p> <p>Unprogrammed controllers</p>			

P Robot positioners



Simply specify a point number to operate
 TS series robot positioners can be operated simply by assigning point numbers and inputting the start command. They can also perform point moves and push moves without the need for writing a program. Velocity can also be changed during motion.

D Robot drivers

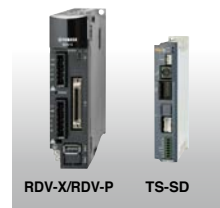

Pulse train input drivers
 These drivers have done away with operations that use robot languages and use the pulse train input method instead. Their compact design allows them to be built easily into control consoles.

C Robot controllers

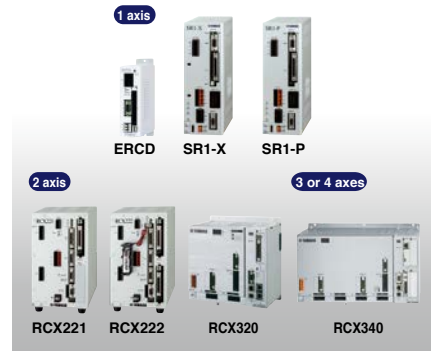

Diverse command methods

There are different methods to choose from: programs, point trace, remote command, online command, and more. Programs use a BASIC-like Yamaha language capable of executing various operations, be it simple tasks, or I/O output and conditional branching.

Comprehensive software

The applications for the controllers are designed to let users operate the robots, teach points, create and edit programs, and perform other tasks simply and easily on the screen.



*Web download only.

RCiVY2+ System

ROBOT VISION FOR THE RCX320/340

Yamaha's own unique solution for integrated robot vision
Advanced RCiVY2+ has been launched.



RCiVY2+ features:

- Adjusting parts orientation on the fly
- Searching randomly placed part
- Conveyor follower
- Top/bottom judgement
- OK/NG judgement

NEW

High speed positioning of irregular shaped parts (foods or clothes)

Blob search function

Suitable for pick & place or detection of parts with wide tolerance in shape and size, or high speed counting.

Detection speed is 2 to 10 times faster than edge detection.



Also supports moving camera

Even if the camera is mounted on the robot, coordinates are automatically converted according to the robot's movement.

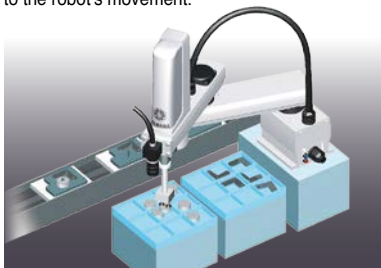

Camera position can be selected in accordance with the application.

Fixed camera Fixed downward Fixed upward

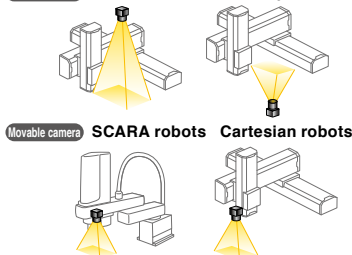

Even when the camera is moved, the coordinates are corrected automatically.

Robot controller integrated type RCiVY2+ system

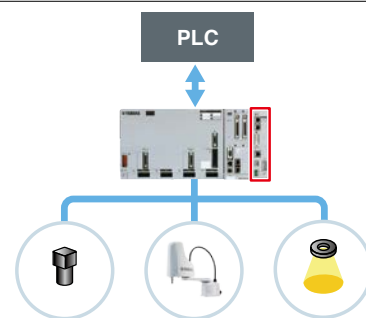

- 1 Simple calibration function is incorporated.
 - 2 Coordinates are corrected automatically even when the camera moves.
 - 3 High-speed connections through dedicated bus line.
 - 4 Controller is incorporated to provide the central operation.
 - 5 Applicable to all models of YAMAHA robot lineup.
- Easy to use
 - Various applications are supported using easy operation.
 - Cost reduction by reducing work steps.
 - Robot and vision supported by Yamaha

Conveyor tracking

Ideal for high-speed packaging arrangement high-speed transport of multiple types of items such as pharmaceuticals, cosmetics, and food products. The vision camera detects the position and orientation of parts moving on the conveyor, and the robot picks them up.

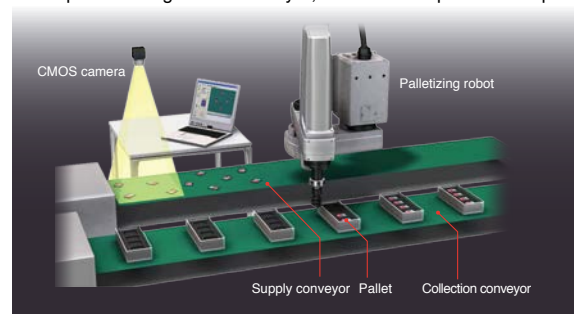

Setup time reduced greatly

When using third-party vision, a coordinate conversion program needs to be created in the robot controller since the robot coordinate data differs from the vision format. In RCiVY2+, vision system is incorporated in robot controller the robot coordinate data can be stored into the robot point data using single process. This ensures very simple operation. Additionally, the unified control of the camera control and light control can be performed using the robot program. Start-up process will be greatly simplified.

Comparison of setup time

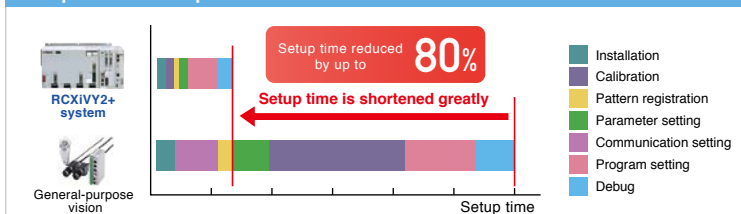

Example program

① New CTMOVE CTMOVE (1),Z=0.0,CTZ=10.0

Can be executed with a single command Unify the move up command, follow workpiece command, move down command

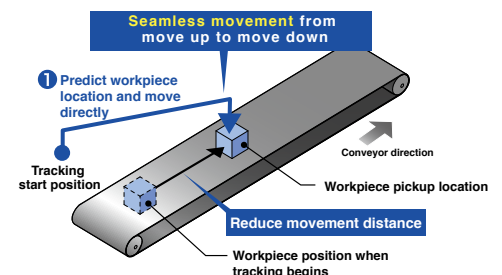

Operating conditions: YK500XG / payload 1 kg (total of workpiece and tool) / horizontal movement 250 mm / vertical movement 1 mm / conveyor speed 100 mm/sec

YRG Series

ELECTRIC GRIPPERS

See p. 29 for a quick selection table



Easy operation enabled by Yamaha's robot language.

Gripping force control

Can be set in increments of 1% in the range of 30 to 100%

Measuring

Measures a workpiece by detecting its position

Speed control

Speed can be set in increments of 1% in the range of 30 to 100%, and the range of 1 to 100% for acceleration

Multi-point control

Up to 10,000 positioning points possible

Workpiece check function

The HOLD signal determines if workpieces have been picked up or dropped, even without the use of a sensor

S type Single cam type

Fast, compact, lightweight



YRG-2005SS YRG-2010S YRG-2815S YRG-4225S

W type Double cam type

High gripping force



YRG-2005W YRG-2810W YRG-4220W

Screw type

Straight style
High precision, long stroke



YRG-2020FS/YRG-2840FS

"T" style

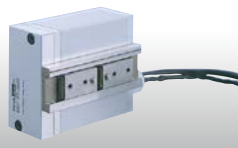

YRG-2020FT/YRG-2840FT

3-finger type

Compact, high rigidity, long stroke



YRG-2004T YRG-2013T YRG-2820T YRG-4230T

Electric grippers for positioning, speed control, and high-precision gripping performance

YRG grippers deliver what was challenging for the air-driven ones—gripping force control, speed and acceleration control, multi-point positioning, and the ability to measure workpieces, making them suitable for catering to a wide range of applications.

Gripping force control

YRG grippers' gripping force can be set in 1% increments. They are capable of gripping glass, spring, and other workpieces that are fragile or easily deformed. The gripper force remains constant even with finger position changes.

Pneumatic control

Difficult to make fine adjustments to the regulator.



Electric control

Gripping force can be set in a range of 30% to 100% in 1% increments.



Multi-point control

Gripper fingers can be configured to desired positions that correspond to workpiece sizes. This feature improves the efficiency of assembly lines, where changeovers are frequent and different workpiece sizes and materials are found.

Pneumatic control

Results in stroke loss.

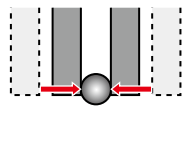

Electric control

High positioning accuracy prevents stroke loss.

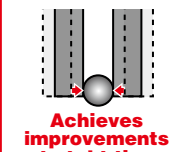

Achieves improvements to takt time

Workpiece check function

The electric grippers output the HOLD signal, which checks for workpieces that were not gripped or dropped during transfer. No external sensor is needed.

Pneumatic control

Image processor or sensor detects workpieces that were dropped or missed out.

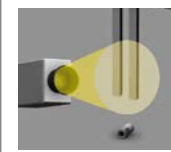

Electric control

Detects fallen workpieces without an external sensor.

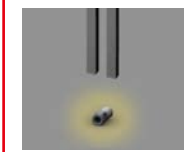

Only a single controller needed for control

The grippers require just a single controller. Setup and startup are significantly simpler as there is no need for communication with PLCs or other host devices.

Supports a variety of applications by being combined with vision system

With YRG grippers integrated into the robot vision system iVY2, RCX340 can be used to control the camera for positioning and workpiece handling. An advanced system, but easily constructed.

*The RCX240 controller can be used too.

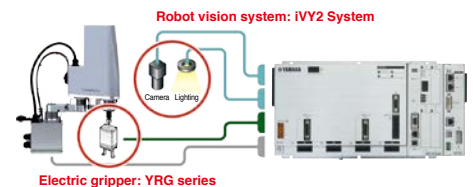

LCMR200

LINEAR CONVEYOR MODULE

See p. 30-31 for a quick selection table

Proposed by the pioneer of linear transport:
 Revolutionary transport platform
 for next generation manufacturing

Production line using LCMR200

- Reduce transport time.
- Improve productivity.
- Cost reduction
- Save space.

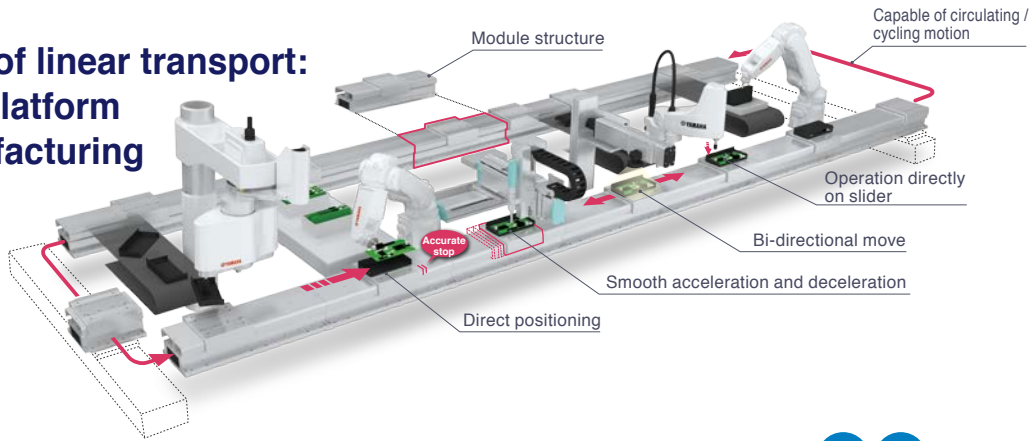

Process sharing

- Direct drive
- Slider backward travel



- Carriage is bi-directional and one work station can perform more than one task. Saving total line cost and floor space.
- High speed bi-directional move and simultaneous independent operation of multiple carriages.

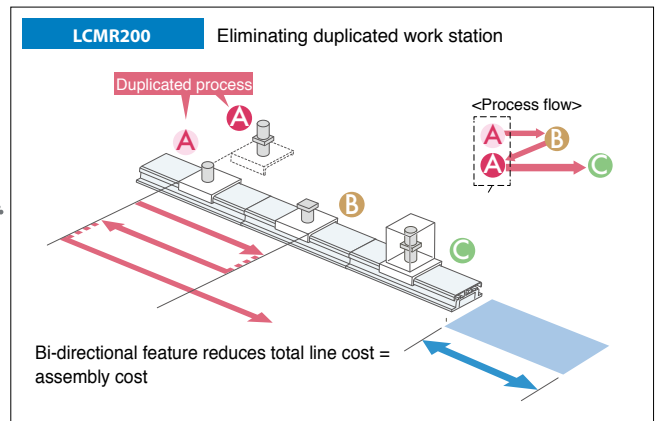
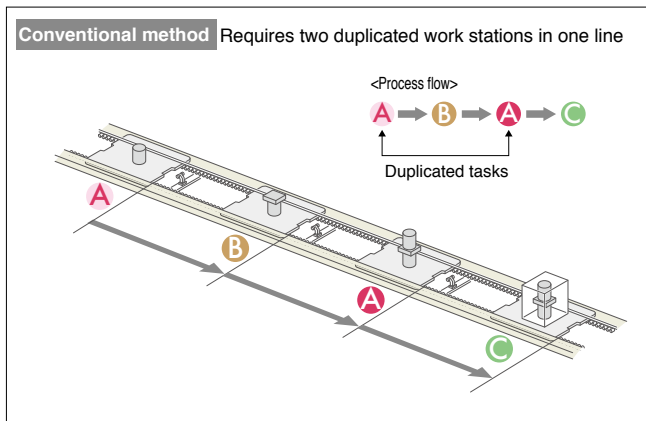

Reduce transport time. <Comparison between LCMR200 and a conventional conveyor>

	Transfer	Stop	Work	Transfer
LCMR200	<p>Linear motor drive for high-speed transfer</p>	<p>Direct positioning Accurate stop Optimum acceleration/ deceleration ensures a smooth deceleration and stop</p>	<p>Work on the slider is possible Slider is supported directly by a highly rigid guide</p>	<p>High-speed movement</p>
Conventional conveyor	<p>Slow transport due to frictional resistance</p>	<p>Requires some distance for deceleration</p>	<p>Collides All stop positions require a sensor and stopper</p>	<p>Workpiece retraction is required because the system does not have rigidity</p>



Variable speed control between work stations.

Direct drive **Narrow pitch operation**



- Servo controlled direct drive eliminates mechanical stoppers and position sensors.
- Simple position setting by entering point data in a program.
- Flexibility in setup for production lot change
- Saving flow time by narrow pitch incremental move and high speed move.

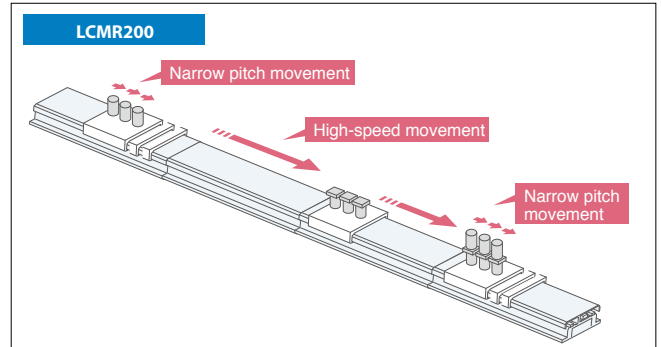

Assembly can be done while parts are on conveyor

Highly rigid guide



- The highly rigid guide enables assembly and processing on the transport line.
- No need to reposition parts to/from conveyor. Floor line space is reduced substantially.

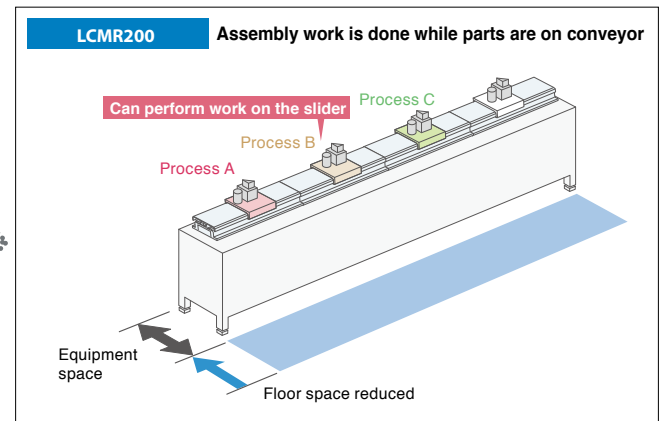
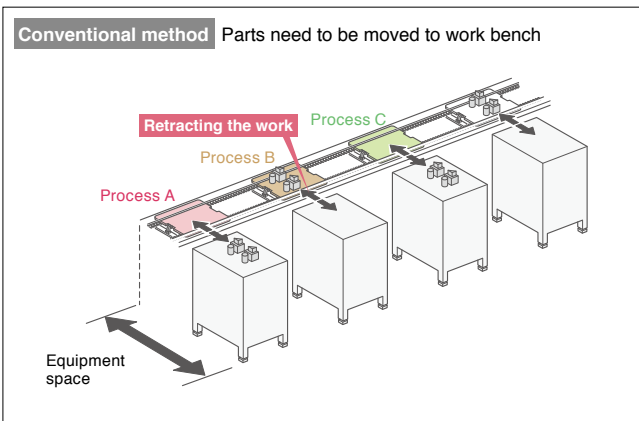

ed

Finished

Transfer time is reduced from **6** to **3** seconds.

50%
reduction
in tact time

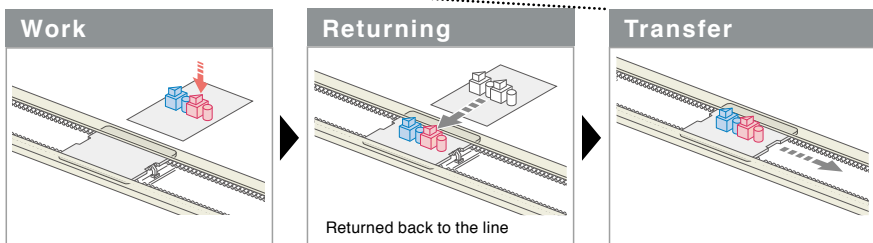

Note. May vary depending on conditions

Controller

Controller for LCMR200
YHX controller



- One YHX controller set can control the entire LCMR200.
- Stacking structure does not require any wiring among the units.

Robonity MOTOR-LESS SINGLE AXIS ACTUATOR

Basic model LBAS

Motor-less

Slider type

Model	LBAS04			LBAS05			LBAS08			LBAS12				
Applicable motor (W)	50			100			200			200				
Repeatability (mm) ^{Note 1}	±0.01			±0.01			±0.01			±0.01				
Deceleration mechanism	Shifting position ball screw φ10 (C7 class)			Shifting position ball screw φ12 (C7 class)			Shifting position ball screw φ16 (C7 class)			Shifting position ball screw φ16 (C7 class)				
Stroke (mm)	50 to 800 (50 pitch)			50 to 800 (50 pitch)			50 to 1100 (50 pitch)			50 to 1250 (50 pitch)				
Maximum speed (mm/sec) ^{Note 2} (or equivalent)	800	400		1333	666	333	1200	600	300	1800	1200	600	300	
Ball screw lead (mm)	12	6		20	10	5	20	10	5	32	20	10	5	
Maximum payload (kg) ^{Note 3} (or equivalent)	Horizontal		12	20	12	24	40	40	80	100	20	40	80	100
	Vertical		2	5	3	6	12	8	20	30	3	8	20	30
Rated thrust (N) ^{Note 3} (or equivalent)	71	141		84	169	339	174	341	683	105	170	341	683	
Maximum dimensions of cross section of main unit (mm)	W 44 × H 52			W 54 × H 60			W 82 × H 78			W 120 × H 76				
Overall length (mm)	Straight		ST + 214			ST + 220.5			ST + 278			ST + 294		
	Bending		ST + 196			ST + 200			ST + 264.5			ST + 270.5		
Using ambient temperature and humidity	0 to 40 °C, 35 to 80 %RH (non-condensing)													

Note 1. Positioning repeatability in one direction.

Note 2. When a moving distance is short and depending on an operation condition, it may not reach the maximum speed.

When the effective stroke exceeds: LBAS04: 500 mm, LBAS05: 550 mm, LBAS08: 650 mm, LBAS12: 600 mm, ball screw resonance may occur depending on the operating area. (Critical speed)

At this time, make the adjustment to decrease the speed while referring to the maximum speed shown in the table.

Note 3. The rated thrust and maximum transferable weight are values assuming the attached motor outputs the rated torque.

Advanced model LGXS

Motor-less

Slider type

Model	LGXS05			LGXS05L			LGXS07					
Applicable motor (W)	50			100			100					
Repeatability (mm) ^{Note 1}	±0.005			±0.005			±0.005					
Deceleration mechanism	Ground ball screw φ 12 (C5 class)			Ground ball screw φ 12 (C5 class)			Ground ball screw φ 15 (C5 class)					
Stroke (mm)	50 to 800 (50 pitch)			50 to 800 (50 pitch)			50 to 1100 (50 pitch)					
Maximum speed (mm/sec) ^{Note 2} (or equivalent)	1333	666	333	1333	666	333	1800	1200	600	300		
Ball screw lead (mm)	20	10	5	20	10	5	30	20	10	5		
Maximum payload (kg) ^{Note 3} (or equivalent)	Horizontal		5	8	13	12	24	32	10	25	45	85
	Vertical		2	4	8	3	6	12	2	4	8	16
Rated thrust (N) ^{Note 3} (or equivalent)	41	69	138	84	169	339	56	84	169	339		
Maximum dimensions of cross section of main unit (mm)	W 48 × H 65			W 48 × H 65			W 70 × H 76.5					
Overall length (mm)	ST + 131.5			ST + 161.5			ST + 202					
Degree of cleanliness ^{Note 4}	ISO CLASS 3 (ISO14644-1) or equivalent											
Intake air (Nℓ/min) ^{Note 5}	30 to 100			30 to 100			30 to 115					
Using ambient temperature and humidity	0 to 40 °C, 35 to 80 %RH (non-condensing)											

Model	LGXS10				LGXS12				LGXS16			LGXS20				
Applicable motor (W)	200				400				750			750				
Repeatability (mm) ^{Note 1}	±0.005				±0.005				±0.005			±0.005				
Deceleration mechanism	Ground ball screw φ 15 (C5 class)				Ground ball screw φ 15 (C5 class)				Ground ball screw φ 20 (C5 class)			Ground ball screw φ 20 (C5 class)				
Stroke (mm)	100 to 1250 (50 pitch)				100 to 1250 (50 pitch)				100 to 1450 (50 pitch)			100 to 1450 (50 pitch)				
Maximum speed (mm/sec) ^{Note 2} (or equivalent)	1800	1200	600	300	1800	1200	600	300	2400	1200	600	2400	1200	600		
Ball screw lead (mm)	30	20	10	5	30	20	10	5	40	20	10	40	20	10		
Maximum payload (kg) ^{Note 3} (or equivalent)	Horizontal		25	40	80	100	35	50	95	115	45	95	130	65	130	160
	Vertical		4	8	20	30	8	15	25	45	12	28	55	15	35	65
Rated thrust (N) ^{Note 3} (or equivalent)	113	170	341	683	225	339	678	1360	320	640	1280	320	640	1280		
Maximum dimensions of cross section of main unit (mm)	W 100 × H 99.5				W 125 × H 101				W 160 × H 130			W 200 × H 140				
Overall length (mm)	ST + 175.5				ST + 211.5				ST + 242.5			ST + 288.5				
Degree of cleanliness ^{Note 4}	ISO CLASS 3 (ISO14644-1) or equivalent															
Intake air (Nℓ/min) ^{Note 5}	30 to 90															
Using ambient temperature and humidity	0 to 40 °C, 35 to 80 %RH (non-condensing)															

Note 1. Positioning repeatability in one direction.

Note 2. When a moving distance is short and depending on an operation condition, it may not reach the maximum speed.

When the effective stroke exceeds: LGXS05/LGXS05L: 600mm, LGXS07/LGXS10/LGXS12: 700mm, LGXS16/LGXS20: 800mm, ball screw resonance may occur depending on the operating area. (Critical speed)

At this time, make the adjustment to decrease the speed while referring to the maximum speed shown in the table.

Note 3. The rated thrust and maximum transferable weight are values assuming the attached motor outputs the rated torque.

Note 4. When using in a clean environment, attach a suction air joint. The degree of cleanliness is the cleanliness level achieved when using at 1000 mm/sec or less.

Note 5. The required suction amount will vary according to the operating conditions and operating environment.

Basic model LBAR

Motor-less

Rod type

Model	LBAR04		LBAR05			LBAR08				
Applicable motor (W)	50		100			200				
Repeatability (mm) ^{Note 1}	±0.01		±0.01			±0.01				
Deceleration mechanism	Shifting position ball screw φ10 (C7 class)		Shifting position ball screw φ12 (C7 class)			Shifting position ball screw φ16 (C7 class)				
Stroke (mm)	50 to 500 (50 pitch)		50 to 600 (50 pitch)			50 to 800 (50 pitch)				
Maximum speed (mm/sec) ^{Note 2} ^{Note 3} (or equivalent)	720	360	1200	600	300	1200	600	300		
Ball screw lead (mm)	12	6	20	10	5	20	10	5		
Maximum payload (kg) ^{Note 3} (or equivalent)	Horizontal		15	25	15	25	50	30	60	80
	Vertical		3	5	4	8	16	8	20	30
Max. pressing force ^{Note 3}	83	167	100	200	400	201	402	804		
Rotating backlash	±0 °		±0 °			±0 °				
Maximum dimensions of cross section of main unit (mm)	W 44 × H 46		W 54 × H 54.7			W 82 × H 73.5				
Overall length (mm)	Straight		ST + 263			ST + 269.5				
	Bending		ST + 245			ST + 249				
Using ambient temperature and humidity	0 to 40 °C, 35 to 80 %RH (non-condensing)									

Note 1. Positioning repeatability in one direction.

Note 2. When a moving distance is short and depending on an operation condition, it may not reach the maximum speed.

When the effective stroke exceeds: LBAR04: 300mm, LBAR05: 350mm, LBAR08: 400mm, ball screw resonance may occur depending on the operating area. (Critical speed)

At this time, make the adjustment to decrease the speed while referring to the maximum speed shown in the table.

Note 3. The described specifications may not be satisfied depending on the installed motor.

Robonity SINGLE-AXIS ROBOTS

Basic model ABAS

With motor

Slider type

Model	ABAS04		ABAS05			ABAS08			ABAS12				ABAS12H				
AC servo motor output (W)	50		100			200			200				400				
Repeatability (mm) ^{Note 1}	±/0.01		±/0.01			±/0.01			±/0.01				±/0.01				
Deceleration mechanism	Shifting position ball screw φ10 (C7 class)		Shifting position ball screw φ12 (C7 class)			Shifting position ball screw φ16 (C7 class)			Shifting position ball screw φ16 (C7 class)				Shifting position ball screw φ16 (C7 class)				
Stroke (mm)	50 to 800 (50 pitch)		50 to 800 (50 pitch)			50 to 1100 (50 pitch)			50 to 1250 (50 pitch)				50 to 1250 (50 pitch)				
Maximum speed (mm/sec) ^{Note 2} (or equivalent)	800	400	1333	666	333	1200	600	300	1800	1200	600	300	1800	1200	600	300	
Ball screw lead (mm)	12	6	20	10	5	20	10	5	32	20	10	5	32	20	10	5	
Maximum payload (kg) (or equivalent)	Horizontal		12	20	12	24	40	40	80	100	20	40	80	100	35	50	95
	Vertical		2	5	3	6	12	8	20	30	3	8	20	30	8	15	25
Rated thrust (N) (or equivalent)	71	141	84	169	339	174	341	683	105	170	341	683	218	339	678	1360	
Maximum dimensions of cross section of main unit (mm)	W 44 × H 52		W 54m × H 60			W 82 × H 78			W 120 × H 76				W 120 × H 76				
Overall length (mm)	Straight		ST + 277.5			ST + 295			ST + 353				ST + 369				
	Bending		ST + 196			ST + 200			ST + 264.5				ST + 270.5				
Position detector	Absolute encoder Battery-less absolute encoder																
Resolution	23 bits																
Using ambient temperature and humidity	0 to 40 °C, 35 to 80 %RH (non-condensing)																

Note 1. Positioning repeatability in one direction.

Note 2. When a moving distance is short and depending on an operation condition, it may not reach the maximum speed.

When the effective stroke exceeds: ABAS04: 500 mm, ABAS05: 550 mm, ABAS08: 650 mm, ABAS12/ABAS12H: 600 mm, ball screw resonance may occur depending on the operating area. (Critical speed) At this time, make the adjustment to decrease the speed while referring to the maximum speed shown in the table.

Advanced model AGXS

With motor

Slider type

Model	AGXS05			AGXS05L			AGXS07						
AC servo motor output (W)	50			100			100						
Repeatability (mm) ^{Note 1}	±/0.005			±/0.005			±/0.005						
Deceleration mechanism	Ground ball screw φ 12 (C5 class)			Ground ball screw φ 12 (C5 class)			Ground ball screw φ 15 (C5 class)						
Stroke (mm)	50 to 800 (50 pitch)			50 to 800 (50 pitch)			50 to 1100 (50 pitch)						
Maximum speed (mm/sec) ^{Note 2} (or equivalent)	1333	666	333	1333	666	333	1800	1200	600	300			
Ball screw lead (mm)	20	10	5	20	10	5	30	20	10	5			
Maximum payload (kg) (or equivalent)	Horizontal			5	8	13	12	24	32	10	25	45	85
	Vertical			2	4	8	3	6g	12	2	4	8	16
Rated thrust (N) (or equivalent)	41	69	138	84	169	339	56	84	169	339			
Maximum dimensions of cross section of main unit (mm)	W 48 × H 65			W 48 × H 65			W 70 × H 76.5						
Overall length (mm)	Straight			ST + 195			ST + 236			ST + 276.5			
	Bending			ST + 161.5			ST + 191.5			ST + 232			
Degree of cleanliness ^{Note 3}	ISO CLASS 3 (ISO14644-1) or equivalent												
Intake air (Nℓ/min) ^{Note 4}	30 to 100			30 to 100			30 to 115						
Position detector	Absolute encoder Battery-less absolute encoder												
Resolution	23 bits												
Using ambient temperature and humidity	0 to 40 °C, 35 to 80 %RH (non-condensing)												

Model	AGXS10				AGXS12				AGXS16				AGXS20			
AC servo motor output (W)	200				400				750				750			
Repeatability (mm) ^{Note 1}	±/0.005				±/0.005				±/0.005				±0.005			
Deceleration mechanism	Ground ball screw φ 15 (C5 class)				Ground ball screw φ 15 (C5 class)				Ground ball screw φ 20 (C5 class)				Ground ball screw φ 20 (C5 class)			
Stroke (mm)	100 to 1250 (50 pitch)				100 to 1250 (50 pitch)				100 to 1450 (50 pitch)				100 to 1450 (50 pitch)			
Maximum speed (mm/sec) ^{Note 2} (or equivalent)	1800	1200	600	300	1800	1200	600	300	2400	1200	600	300	2400	1200	600	
Ball screw lead (mm)	30	20	10	5	30	20	10	5	40	20	10	5	40	20	10	
Maximum payload (kg) (or equivalent)	Horizontal				25	40	80	100	35	50	95	115	45	95	130	65
	Vertical				4	8	20	30	8	15	25	45	12	28	55	15
Rated thrust (N) (or equivalent)	113	170	341	683	225	339	678	1360	320	640	1280	320	640	1280		
Maximum dimensions of cross section of main unit (mm)	W 100 × H 99.5				W 125 × H 101				W 160 × H 130				W 200 × H 140			
Overall length (mm)	Straight				ST + 250.5				ST + 302.5				ST + 344.8			
	Bending				ST + 220.5				ST + 256.5				ST + 294.5			
Degree of cleanliness ^{Note 3}	ISO CLASS 3 (ISO14644-1) or equivalent															
Intake air (Nℓ/min) ^{Note 4}	30 to 90				30 to 90				30 to 90				30 to 90			
Position detector	Absolute encoder Battery-less absolute encoder															
Resolution	23 bits															
Using ambient temperature and humidity	0 to 40 °C, 35 to 80 %RH (non-condensing)															

Note 1. Positioning repeatability in one direction.

Note 2. When a moving distance is short and depending on an operation condition, it may not reach the maximum speed.

When the effective stroke exceeds: AGXS05/AGXS05L: 600mm, AGXS07/AGXS10/AGXS12: 700mm, AGXS16/AGXS20: 800mm, ball screw resonance may occur depending on the operating area. (Critical speed) At this time, make the adjustment to decrease the speed while referring to the maximum speed shown in the table.

Note 3. When using in a clean environment, attach a suction air joint. The degree of cleanliness is the cleanliness level achieved when using at 1000 mm/sec or less.

Note 4. The required suction amount will vary according to the operating conditions and operating environment.

Basic model ABAR

With motor

Rod type

Model	ABAR04		ABAR05		ABAR08	
AC servo motor output (W)	50		100		200	
Repeatability (mm) ^{Note 1}	±/0.01		±/0.01		±/0.01	
Deceleration mechanism	Shifting position ball screw φ10 (C7 class)		Shifting position ball screw φ12 (C7 class)		Shifting position ball screw φ16 (C7 class)	
Stroke (mm)	50 to 500 (50 pitch)		50 to 600 (50 pitch)		50 to 800 (50 pitch)	
Maximum speed (mm/sec) ^{Note 2} (or equivalent)	720	360	1200	600	300	1200
Ball screw lead (mm)	12	6	20	10	5	20
Maximum payload (kg) (or equivalent)	Horizontal		15	25	15	25
	Vertical		3	5	4	8
Max. pressing force ^{Note 3}	83	167	100	200	400	201
Rotating backlash	±/0 °		±/0 °		±/0 °	
Maximum dimensions of cross section of main unit (mm)	W 44 × H 46		W 54 × H 54.7		W 82 × H 73.5	
Overall length (mm)	Straight		ST + 326.5		ST + 344	
	Bending		ST + 245		ST + 249	
Position detector	Absolute encoder Battery-less absolute encoder					
Resolution	23 bits					
Using ambient temperature and humidity	0 to 40 °C, 35 to 80 %RH (non-condensing)					

Note 1. Positioning repeatability in one direction.

Note 2. When a moving distance is short and depending on an operation condition, it may not reach the maximum speed.

When the effective stroke exceeds: ABAR04: 300mm, ABAR05: 350mm, ABAR08: 400mm, ball screw resonance may occur depending on the operating area. (Critical speed) At this time, make the adjustment to decrease the speed while referring to the maximum speed shown in the table.

TRANSEVO CLOSED LOOP STEPPER MOTOR SINGLE-AXIS ROBOTS

Type	Size ¹ (mm) (W x H)	Model	Lead (mm)	Maximum payload ² (kg)		Maximum speed ³ (mm/sec)	Stroke (mm)
				Horizontal	Vertical		
					SR		
SS type (Slide type) Inline model / Foldback model	49 x 59	SS04-S SS04-R(L)	12	2	1	600	50 to 400
			6	4	2	300	
			2	6	4	100	
	55 x 56	SS05-S SS05-R(L)	20	4	-	1000	50 to 800
			12	6	1	600	
			6	10	2	300	
	55 x 56	SS05H-S SS05H-R(L)	20	6	-	1000	50 to 800
			12	8	2	600 (Horizontal) 500 (Vertical)	
			6	12	4	300 (Horizontal) 250 (Vertical)	
SG type (Slide type)	65 x 64	SG07	20	36	4	1200	50 to 800
			12	43	12	800	
			6	46	20	350	
SR type (Rod type standard) Inline model / Foldback model	48 x 56.5	SR03-S SR03-R(L) SR03-U	12	10	4	500	50 to 200
			6	20	8	250	
			12	25	5	500	
	48 x 58	SR04-S SRD04-R(L)	6	40	12	250	50 to 300
			2	45	25	80	
			12	50	10	300	
	56.4 x 71	SR05-S SRD05-R(L)	6	55	20	150	50 to 300
			2	60	30	50	
			12	10	3.5	500	
SR type (Rod type with support guide) Inline model / Foldback model	105 x 56.5	SRD03-S SRD03-U	6	20	7.5	250	50 to 200
			12	25	4	500	
			6	40	11	250	
	135 x 58	SRD04-S SRD04-U	2	45	24	80	50 to 300
			12	50	8.5	300	
			6	55	18.5	150	
	157 x 71	SRD05-S SRD05-U	2	60	28.5	50	50 to 300
			6	6	2	200	
			10	4	1	400	
STH type (Slide table type) Inline model/ Foldback model	45 x 46	STH04-S	5	6	2	200	50 to 100
	73 x 51	STH04-R(L) ^{*4}	10	4	1	400	
	61 x 65	STH06	8	9	2	150	50 to 150
	106 x 70	STH06-R(L)	16	6	4	400	

Type	Height (mm)	Model	Torque type	Rotational torque (N/m)	Maximum pushing torque (N/m)	Maximum speed ³ (mm/sec)	Rotation range (°)
STH type (Rotary type) Standard/High rigidity	42(Standard)	RF02-N	N: Standard	0.22	0.11	420	310(RF02-N) 360(RF02-S)
	49(High rigidity)	RF02-S	H: High torque	0.32	0.16	280	
	53(Standard)	RF03-N	N: Standard	0.8	0.4	420	320(RF03-N) 360(RF03-S)
	62(High rigidity)	RF03-S	H: High torque	1.2	0.6	280	
	68(Standard)	RF04-N	N: Standard	6.6	3.3	420	320(RF04-N) 360(RF04-S)
	78(High rigidity)	RF04-S	H: High torque	10	5	280	

Type	Size ¹ (mm) (W x H)	Model	Lead (mm)	Maximum payload ² (kg)		Maximum speed ³ (mm/sec)	Stroke (mm)
				Horizontal	Vertical		
BD type (Belt type)	40 x 40	BD04	48	1	-	1100	300 to 1000
	58 x 48	BD05	48	5	-	1400	300 to 2000
	70 x 60	BD07	48	14	-	1500	300 to 2000

*1. Approximate size of unit's cross section.

*2. Payload varies with operation speed. For details, see the appropriate page of manufacturer's catalog.

*3. Maximum speed varies with stroke length and payload. For details, see the appropriate page of manufacturer's catalog.

*4. Brake option is not available for STH04-R(L)-**50.

■ Allowable ambient temperature for robot installation SS/SR type: 0-40C, STH/RF/BD type: 5-40C

FLIP - X SINGLE-AXIS ROBOTS

Type	Size*1 (mm) (W x H)	Model	Lead (mm)	Maximum payload (kg)		Maximum speed (mm/sec)	Stroke (mm)
				Horizontal	Vertical		
T type Compact model	45 x 53	T4L/T4LH	12	4.5	1.2	720	50 to 400
			6	6	2.4	360	
			2	6	7.2	120	
	55 x 52	T5L/T5LH	20	3	-	1200	50 to 800
			12	5	1.2	800	
			6	9	2.4	400	
	65 x 56	T6L	20	10	-	1333	50 to 800
			12	12	4	800	
			6	30	8	400	
	94 x 98	T9 (Standard)	30	15	-	1800	150 to 1050
			20	30	4	1200	
			10	55	10	600	
			5	80	20	300	
		T9H (High thrust)	30	25	-	1800	150 to 1050
			20	40	8	1200	
10			80	20	600		
5			100	30	300		
F type High rigidity model	80 x 65	F8	20	12	-	1200	150 to 800
			12	20	4	720	
			6	40	8	360	
	80 x 65	F8L	30	7	-	1800	150 to 1050
			20	20	4	1200	
			10	40	8	600	
			5	50	16	300	
	80 x 65	F8LH	20	30	-	1200	150 to 1050
			10	60	-	600	
			5	80	-	300	
	110 x 71	F10	30	15	-	1800	150 to 1050
			20	20	4	1200	
			10	40	10	600	
		F10H (High thrust)	5	60	20	300	150 to 1000
			30	25	-	1800	
			20	40	8	1200	
	136 x 83	F14 (Standard)	10	80	20	600	150 to 1050
			5	80	20	300	
			30	25	-	1800	
			20	40	8	1200	
		F14H (High thrust)	10	80	20	600	
			5	100	30	300	
			30	15	-	1800	
			20	30	4	1200	
168 x 100	F17L	50	50	10	2200	1100 to 2050	
		40	40	-	2400	200 to 1450	
	F17	20	80	15	1200	200 to 1250	
		10	120	35	600	200 to 1450	
		40	60	-	2400	200 to 1250	
202 x 115	F20	20	120	25	1200	200 to 1250	
		10	-	45	600	200 to 1250	
202 x 120	F20N	20	80	-	1200	1150 to 2050	
GF type High rigidity model	145 x 91.5	GF14XL	20	45	-	1200	750 to 2000
	168 x 105.5	GF17XL	20	90	-	1200	850 to 2500
N type Nut rotation model	145 x 120	N15 (Single carriage)	20	50	-	1200	500 to 2000
		N15D (Double carriage)					250 to 1750
	180 x 115	N18 (Single carriage)		80			500 to 2500
		N18D (Double carriage)					250 to 2250
B type Timing belt drive model	100 x 81	B10	Belt drive	10	-	1875	150 to 2550
	146 x 94	B14 (Standard)	Belt drive	20	-	1875	150 to 3050
		B14H (High thrust)	Belt drive	30	-	1875	
R type Rotation axis model	-	R5	-	0.12kgm ²	-	360°/sec	360°
		R10		0.36kgm ²			
		R20		1.83kgm ²			

*1. Approximate size of unit's cross section.

PHASER LINEAR MOTOR SINGLE-AXIS ROBOTS

Type	Size*1 (mm) (W × H)	Model	Carriage	Maximum payload (kg)	Maximum speed (mm/sec)	Stroke (mm)
MF type Steel cored linear motor with falt magnet	85 × 80	MF7	Single	10 (7) ²	2500	100 to 4000(Horizontal) 100 to 2000(Wall mount)
		MF7D	Double			100 to 3800(Horizontal) 100 to 1800(Wall mount)
	100 × 80	MF15	Single	30 (15) ²		100 to 4000(Horizontal) 100 to 2000(Wall mount)
		MF15D	Double			100 to 3800(Horizontal) 100 to 1800(Wall mount)
	150 × 80	MF20	Single	40 (20) ²		150 to 4050
		MF20D	Double			150 to 3850
		MF30	Single	60 (30) ²		100 to 4000
		MF30D	Double			150 to 3750
	210 × 100	MF75	Single	160 (75) ²		1000 to 4000
		MF75D	Double			680 to 3680

*1. Approximate size of unit's cross section.

*2. Value in brackets refers to the highest payload when the robot is at maximum speed.

GX SINGLE-AXIS ROBOTS

Type	Size*1 (mm) (W × H)	Model	Lead (mm)	Maximum payload (kg)		Maximum speed*2 (mm/sec)	Stroke (mm)
				Horizontal	Vertical		
Small type	W48 × H65	GX05	20	5	2	1333	50 to 800
			10	8	4	665	
			5	13	8	333	
	W48 × H65	GX05L	20	12	3	1333	
			10	24	6	666	
			5	32	12	333	
Medium type	W70 × H76.5	GX07	30	10	2	1800	50 to 1100
			20	25	4	1200	
			10	45	8	600	
	W100 × H99.5	GX10	5	85	16	300	
			30	25	4	1800	
			20	40	8	1200	
Large type	W160 × H130	GX16	10	80	20	600	100 to 1250
			5	100	30	300	
			30	35	8	1800	
	W125 × H101	GX12	20	50	15	1200	
			10	95	25	600	
			5	115	45	300	
Large type	W200 × H140	GX20	40	45	12	2400	100 to 1450
			20	95	28	1200	
			10	130	55	600	
	W160 × H130	GX16	40	65	15	2400	
			20	130	35	1200	
			10	160	65	600	

*1. Approximate size of unit's cross section.

*2. The maximum speed will vary according to the stroke length.

XY - X CARTESIAN ROBOTS

Model	Arm variations					Number of axes	Maximum payload (kg)	Maximum stroke (mm)	
	Arm	Gantry	Moving arm	Pole	XZ			X axis	Y axis
PXYx	√	-	-	-	-	2 axes	4.5	150 to 650	50 to 300
FXYx	√	-	-	-	-	2 axes / 3 axes	12	150 to 1050	150 to 550
FXBYx	√	-	-	-	-	2 axes	7	150 to 2450	150 to 550
SXYx	√	-	√	√	√	2 axes / 3 axes / 4 axes	20	150 to 1050	150 to 650
SXYBx	√	-	-	-	√	2 axes / 3 axes / 4 axes	14	150 to 3050	150 to 550
MXYx	√	√	√	√	√	2 axes / 3 axes / 4 axes	30	250 to 1250	150 to 650
NXY	√	-	-	-	-	2 axes / 3 axes	25	500 to 2000	150 to 650
NXY-W	√	-	-	-	-	4 axes / 6 axes	25	250 to 1750	150 to 650
HXYx	√	√	√	√	√	2 axes / 3 axes / 4 axes	40	250 to 1250	250 to 650
HXYLx	√	√	-	-	-	2 axes	40	1150 to 2050	250 to 650

Note: Maximum payload and maximum stroke length are based on cable carrier specifications or when using the arm type model.

YK-X/YK-XG/YK-XE/YK-TW/YK-XGS/YK-XGP SCARA ROBOTS

Model/Type		Model	Arm length (mm)	Maximum payload (kg)	Standard cycle time (sec.)*1
Completely beltless model	Extra small type	YK120XG	120	1.0	0.33
		YK150XG	150		
		YK180XG	180		
		YK180X	180		
		YK220X	220		
Low cost high performance model	Small type	YK250XG	250	5.0(4.0) ³	0.43
		YK350XG	350		0.44
		YK400XG	400		0.45
Completely beltless model		YK400XE-4	400	4.0(3.0) ³	0.41
Completely beltless model	Medium type	YK500XGL	500	5.0(4.0) ³	0.48
Low cost high performance model		YK500XG	500	10.0(9.0) ³	0.42
Completely beltless model		YK510XE-10	510	10.0(9.0) ³	0.38
Low cost high performance model		YK600XGL	600	5.0(4.0) ³	0.54
Completely beltless model		YK600XG	600	10.0(9.0) ³	0.43
Low cost high performance model	YK610XE-10	610	10.0(9.0) ³	0.39	
Completely beltless model	Large type	YK600XGH	600	20.0(19.0) ³	0.47
Low cost high performance model		YK700XGL	700	10.0(9.0) ³	0.50
Completely beltless model		YK710XE-10	710	10.0(9.0) ³	0.42
Completely beltless model		YK700XG	700	20.0(19.0) ³	0.42
		YK800XG	800		0.48
	YK900XG	900	0.49		
	YK1000XG	1000	0.49		
-		YK1200X	1200	50.0	0.91
Wall mount/inverse model		YK300XGS ²	300	5.0(4.0) ³	0.49
		YK400XGS ²	400		
		YK500XGS	500	10.0(9.0) ³	0.45
		YK600XGS	600		0.46
		YK700XGS	700	20.0(19.0) ³	0.42
		YK800XGS	800		0.48
		YK900XGS	900		0.49
		YK1000XGS	1000		
Dust-proof & drip-proof model		YK250XGP	250	4.0	0.5
		YK350XGP	350		0.52
		YK400XGP	400		0.5
		YK500XGLP	500	4.0	0.66
		YK500XGP	500	10.0	0.55
		YK600XGLP	600	4.0	0.71
		YK600XGP	600	10.0	0.56
		YK600XGHP	600	18.0	0.57
		YK700XGP	700	20.0	0.52
		YK800XGP	800		0.58
		YK900XGP	900		0.59
		YK1000XGP	1000		
Orbit type		YK350TW	350	5.0	0.32
		YK500TW	500	5.0	0.29

*1. **Extra small type** Maximum payload: 0.1kg (100 mm in the horizontal direction, 25 mm in the vertical direction [two-way], rough positioning)
Orbit type Maximum payload: 1 kg (300 mm in the horizontal direction, 25 mm in the vertical direction [two-way], rough positioning)
Other type Maximum payload: 2 kg (300 mm in the horizontal direction, 25 mm in the vertical direction [two-way], rough positioning)

*2. Models YK300XGS and YK400XGS have to be custom-ordered. Please contact Yamaha for details regarding the delivery.

*3. Value in brackets refers to the maximum payload when optional equipment are used (e.g. tool flanges, user wiring/tubing routed through spline shafts).

Y P - X PICK & PLACE ROBOTS

Model	Axes	Structure				Maximum payload (kg)	Cycle time (sec)
		X axis	Y axis	Z axis	R axis		
YP220BX	2 axes	Belt	-	Belt	-	3	0.45
YP320X		Ball screw	-	Belt	-	3	0.57
YP220BXR	3 axes	Belt	-	Belt	Rotation axis	1	0.62
YP320XR		Ball screw	-	Belt	Rotation axis	1	0.67
YP330X		Ball screw	Ball screw	Belt	-	3	0.57
YP340X	4 axes	Ball screw	Ball screw	Belt	Rotation axis	1	0.67

CLEAN ROOM SCARA ROBOTS

Type	Model	Arm length (mm)	Maximum payload (kg)	Standard cycle time (sec)*	Beltless structure
Extra small type	YK180XC	180	1.0	0.42	○
	YK220XC	220	1.0	0.45	○
Small type	YK250XGC	250	4.0	0.5	○
	YK350XGC	350	4.0	0.52	○
	YK400XGC	400	4.0	0.5	○
Medium type	YK500XC	500	10.0	0.53	-
	YK500XGLC	500	4.0	0.66	○
	YK600XC	600	10.0	0.56	-
	YK600XGLC	600	4.0	0.71	○
Large type	YK700XC	700	20.0	0.57	-
	YK800XC	800	20.0	0.57	-
	YK1000XC	1000	20.0	0.60	-

*Extra small type Maximum payload: 0.1kg (100 mm in the horizontal direction, 25 mm in the vertical direction [two-way], rough positioning)

Other type Maximum payload: 2 kg (300 mm in the horizontal direction, 25 mm in the vertical direction [two-way], rough positioning)

CLEAN ROOM SINGLE-AXIS ROBOTS

Type	Model	Size* (mm) (W × H)	Lead (mm)	Maximum payload (kg)		Maximum speed (mm/sec)	Stroke (mm)
				Horizontal	Vertical		
FLIP-XC type	C4L C4LH	45 x 55	12	4.5	1.2	720	50 to 400
			6	6	2.4	360	
			2	6	7.2	120	
	C5L C5LH	55 x 65	20	3	-	1000	50 to 800
			12	5	1.2	800	
			6	9	2.4	400	
	C6L	65 x 65	20	10	-	1000	50 to 800
			12	12	4	800	
			6	30	8	400	
	C8	80 x 75	20	12	-	1000	150 to 800
			12	20	4	720	
			6	40	8	360	
	C8L	80 x 75	20	20	4	1000	150 to 1050
			10	40	8	600	
			5	50	16	300	
	C8LH	80 x 75	20	30	-	1000	150 to 1050
			10	60	-	600	
			5	80	-	300	
	C10	104 x 85	20	20	4	1000	150 to 1050
			10	40	10	500	
5			60	20	250		
C14	136 x 96	20	30	4	1000	150 to 1050	
		10	55	10	500		
		5	80	20	250		
C14H	136 x 96	20	40	8	1000	150 to 1050	
		10	80	20	500		
		5	100	30	250		
C17	168 x 114	20	80	15	1000	250 to 1250	
		10	120	35	600		
C17L	168 x 114	50	50	10	1000	1150 to 2050	
		20	120	25	1000		
C20	202 x 117	20	-	45	1000	250 to 1250	
		10	-	45	500		
SSC type (TRANSERVO)	SSC04	49 x 59	12	2	1	600	50 to 400
			6	4	2	300	
			2	6	4	100	
	SSC05	55 x 56	20	4	-	1000	50 to 800
			12	6	1	600	
			6	10	2	300	
	SSC05H	55 x 56	20	6	-	1000	50 to 800
			12	8	2	600(Horizontal)/ 500(Vertical)	
			6	12	4	300(Horizontal)/ 250(Vertical)	
			6	12	4	300(Horizontal)/ 250(Vertical)	

*Approximate size of unit's cross section.

CLEAN ROOM CARTESIAN ROBOTS

Type	Model	Axes	Moving range (mm)	Maximum speed (mm/sec)	Maximum payload (kg)
2 axes	SXYxC	X	150 to 1050	1000	20
		Y	150 to 650	1000	
3 axes	SXYxC (ZSC12)	X	150 to 1050	1000	3
		Y	150 to 650	1000	
		Z	150	1000	
	SXYxC (ZSC6)	X	150 to 1050	1000	5
		Y	150 to 650	1000	
		Z	150	500	
4 axes	SXYxC (ZRSC12)	X	150 to 1050	1000	3
		Y	150 to 650	1000	
		Z	150	1000	
		R	360°	1020°/sec	
	SXYxC (ZRSC6)	X	150 to 1050	1000	5
		Y	150 to 650	1000	
		Z	150	500	
		R	360°	1020°/sec	

Y R G ELECTRIC GRIPPER

Type	Model	Holding power (N)	Open/close stroke (mm)	Maximum speed (mm/sec)	Repeatability (mm)	Weight (g)
Compact single cam	YRG-2005SS	5	3.2	100	±0.02	90
Single cam	YRG-2010S	6	7.6	100	±0.02	160
	YRG-2815S	22	14.3	100	±0.02	300
Double cam	YRG-4225S	40	23.5	100	±0.02	580
	YRG-2005W	50	5	60	±0.03	200
	YRG-2810W	150	10	60	±0.03	350
	YRG-4220W	250	19.3	45	±0.03	800
Screw type Straight style	YRG-2020FS	50	19	50	±0.01	420
	YRG-2840FS	150	38	50	±0.01	880
Screw type "T" style	YRG-2020FT	50	19	50	±0.01	420
	YRG-2840FT	150	38	50	±0.01	890
3-finger	YRG-2004T	2.5	3.5	100	±0.03	90
	YRG-2013T	2	13	100	±0.03	190
	YRG-2820T	10	20	100	±0.03	340
	YRG-4230T	20	30	100	±0.03	640

- Gripping force control: 30–100% (in 1% increments)
- Multi-point control: 10,000 max.

- Speed control: 20–100% (in 1% increments)
- Workpiece size detection: 0.01 mm (by ZON signal)

- Acceleration control: 1–100% (in 1% increments)

LCMR200

Linear conveyor module

Basic specifications		
Drive method	Linear motor with moving magnet type core	
Position Search	Magnetic absolute position sensor	
Maximum payload	30 kg	
Maximum speed	2,500 mm/sec ^{*1}	
Repeatability	+/-5 μm	
Mechanical tolerance between robot sliders	+/-30 μm (Dowel hole standard)	
Total stroke limit	25.5 m ⁻²	
Maximum number of robot sliders	64 units ⁻²	
Minimum spacing between robot sliders	210 mm ⁻³	
Main frame dimensions	Max. external size of frame cross-section	W175 × H109 mm (Including robot slider)
	Linear module length	200 mm / 300 mm / 500 mm / 1000 mm
	Robot slider length	198 mm
Weight	Linear module	Approx 20 kg [Per 1 m of linear module]
	Robot slider	2.4 kg
Power supply	Control power supply	48 VDC Required power [W] = 75 [W/m] × Overall length of module [m] ⁻⁴
	Motor power supply	48 VDC Yamaha's designated model ⁻⁵
Operating environment	Operating temperature	0 °C to 40 °C ⁻⁶
	Storage temperature	-10 °C to 65 °C
	Operating humidity	35 % to 85 %RH [No condensation]
Controller	YHX controller ⁻⁷	

- *1. When the conveying weight exceeds 10 kg, it will drop to 1,000 mm/sec according to the weight.
- *2. It may differ depending on the system configuration.
- *3. When the jig palette to equip to the robot slider is longer, it shall be the jig palette length + 10 mm.
- *4. The option 600 W power source supplies the power to the linear module with a length of up to 8 m while the 1000 W power source supplies the power to the linear module with a length of up to 13.3 m.
- *5. The option power source can supply the power to up to two robot sliders. (When AC 200 to 240 V is input.)
- *6. Operate LCMR200 in the temperature environment (+/-5 °C) that installation and adjustment were performed.
- *7. The YHX controller requires a separate electrical power supply.

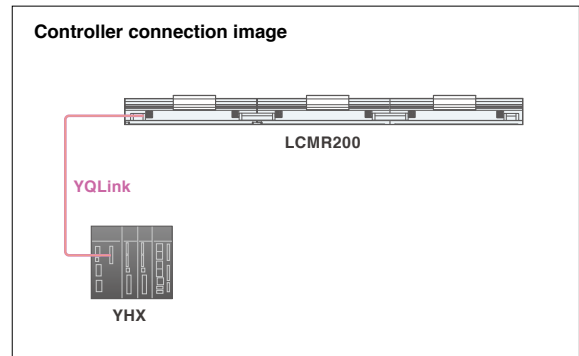

YHX

- Controller for LCMR200
- Controller for GX

Host controller unit YHX-HCU

Item		Host controller unit
Power supply	Control power supply	Voltage: 21.6 to 26.4 VDC (24 V +/-0%) Current: 3.5 A (Including PoE)
	External I/F	Giga bit Ethernet · Compatible with PoE yet 1 port (23 W) · Not compatible with PoE yet 1 port Field network (Slave) Select one from the following 4 kinds. · EtherCAT · CC-Link [*] · EtherNet/IP * A separate adaptor is necessary. · PROFINET USB · USB 2.0 1 Port (Bus power 0.5 A) · USB 3.0 1 port (Bus power 1.0 A)
Connector	HMI	Connector for connecting programming pad
	SAFETY	Emergency stop contact output Enable switch contact output Emergency stop input
	MODE	CPU OK output Programming pad AUTO/MANUAL select key switch output
Indicator	LCD	128 x 64 dots, Yellow
Dimensions		41.6×150×125 (mm)
Weight		750g
Protection structure / Protection rating		IP20 / class 1

Driver power unit YHX-DPU

Item		Driver power unit
Power supply	Control power supply	Voltage: 21.6 to 26.4 VDC (24 V +/-10%) Current: 0.5A
	Main power supply	Input: Single phase / 3-phase 180 to 253 VAC / (200 to 230 VAC +/-10%), 50/60 Hz Power supply capacity: Single phase 3.5 kVA 3-phase 6 kVA
Connection motor capacity		Single phase within 1.6 kW, 3-phase within 3.0kW / Driver unit within 16 units (16 axes)
Connector	Regenerative	Regenerative unit connector
	External I/F	YQLink
	ABS Battery	ABS Battery connector
Dimensions		63.2×150×125 (mm)
Weight		1050g
Protection structure / Protection rating		IP20 / class 1

Driver unit/Servo motor specifications (30A/10A) YHX-A30/A10

Item		Driver unit 30 A/10 A
Power supply	Control power supply	Voltage: 21.6 to 26.4 VDC (24 V +/-10%) Current: 0.8A (Including brake unit power supply)
	ENC.A	Encoder input
Connector	ENC.B	Encoder input (Dedicated application)
	STOP	Gate off input, 2 points Gate status output, 1 point
	MOTOR	Motor drive power supply output Brake power supply output
	ABS Battery	ABS Battery connector
	Fan unit connector	Fan unit is connectable. (YHX-A30 includes the fan unit.)
	Brake unit connector	Brake unit is connectable.
Dimensions		31.6×150×125 (mm)
Weight		30 A : 570g (Including accessory fan unit) / 10 A : 560g
Protection structure / Protection rating		IP20 / class 1

YQLink expansion unit YHX-YQL

Item		YQLink expansion unit
Power supply	Control power supply	Voltage: 21.6 to 26.4 VDC (24 V +/-10%) Current: 0.3A
	External I/F	YQLink
Connector	SAFETY	Emergency stop input
	Dimensions	31.6×150×125 (mm)
Weight		380g
Protection structure / Protection rating		IP20 / class 1

Regenerative unit YHX-RU

Item		Regenerative unit
Power supply	Input	254 to 357 VDC (Controller DCBUS connected)
Connector		Regenerative connector (For connecting regenerative unit / For adding regenerative unit)
Dimensions		62.5×180×110 (mm)
Weight		1450g
Protection structure / Protection rating		IP20 / class 1

Accepting registrations from website

Useful contents from model selections to design, start-up, and maintenance work are provided.

YAMAHA ROBOT WEB MEMBER SITE

<https://global.yamaha-motor.com/business/robot/>

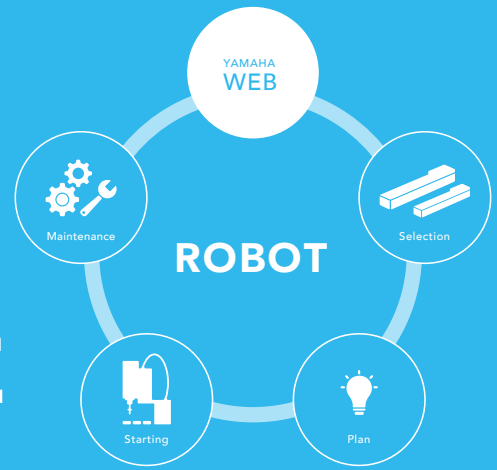

YAMAHA Robot Member Site provides information you can utilize in the model selection or design phase when introducing industrial robots. Additionally, the contents necessary for the start-up or maintenance work are also prepared.

Member Site Contents

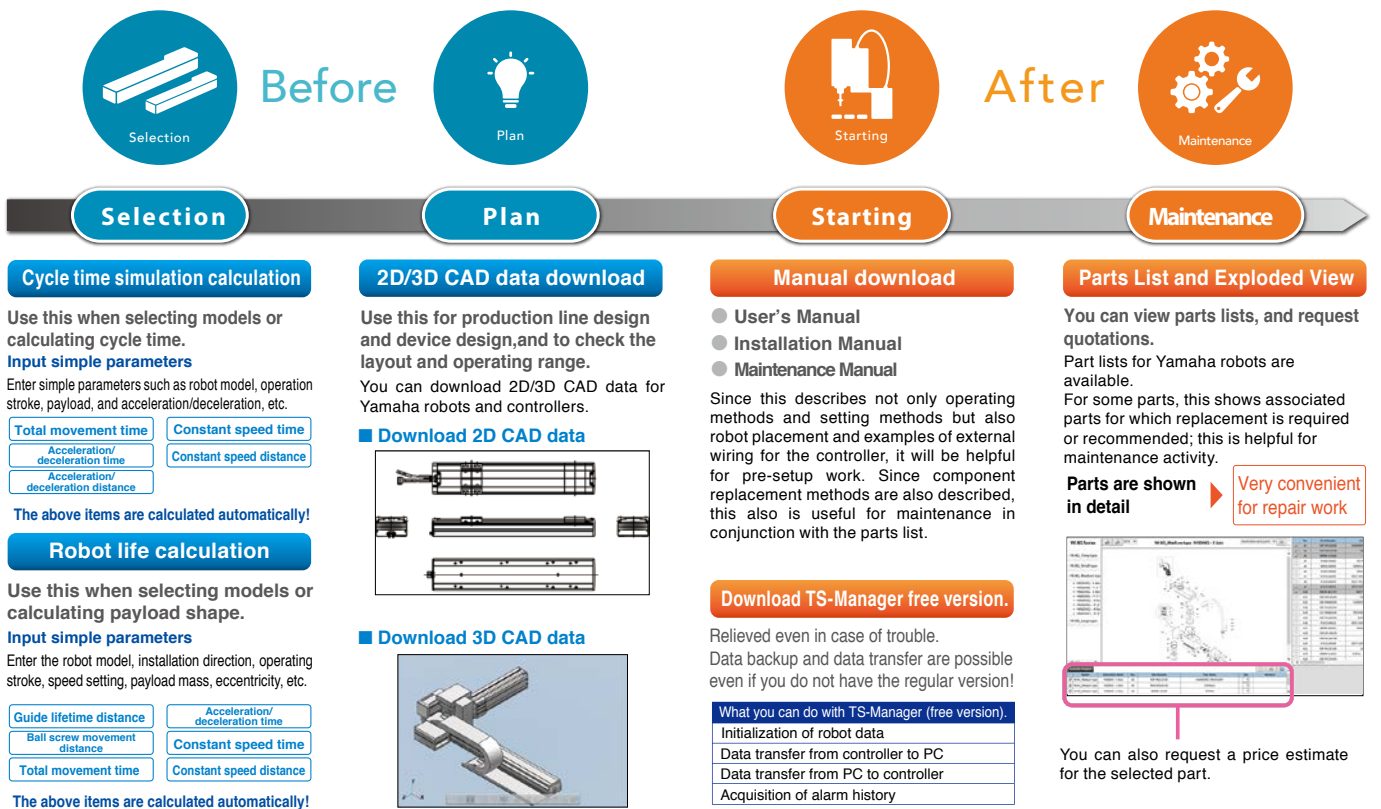

Flow until new member site registration

Go to New Registration screen from the top page

URL <https://global.yamaha-motor.com/business/robot/>

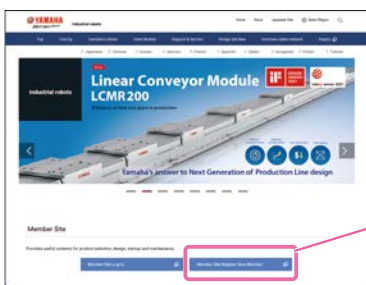

Go to New Registration screen from here

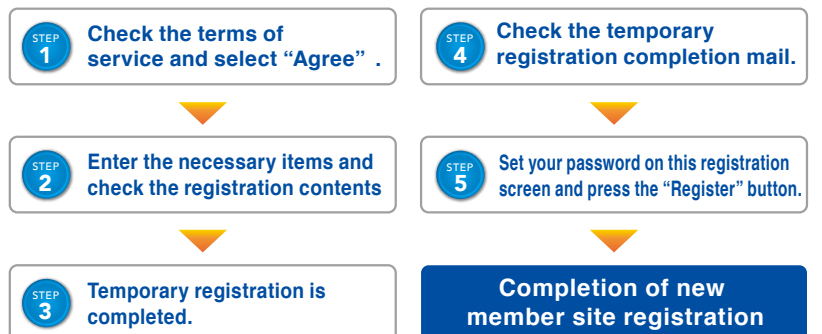

MEMO

MEMO

MEMO



Robotics Operations
Sales & Marketing Section
FA Sales & Marketing Division

127 Toyooka, Kita-ku, Hamamatsu, Shizuoka 433-8103, Japan
Tel. +81-53-525-8350 Fax. +81-53-525-8378

URL <https://global.yamaha-motor.com/business/robot/>

● Specifications and appearance are subject to change without prior notice.

202305-NE